



# CX1277

## 12 inch Coaxial Loudspeaker

*tq*install™  
SERIES



### Overview

The CX1277 is a coaxial loudspeaker that provides the output capability and pattern control of a normal 2-way system in a much more compact enclosure. Its coaxial transducer and 75° x 75° horn provides effective coverage in situations where traditional 45° and 60° vertical patterns are too narrow. Its coverage pattern is particularly effective from an elevated position, and its vertically trapezoidal enclosure shape allows it to be mounted very close to ceilings with minimal effect on sight lines.

Fulcrum Acoustic's **TQ™** processing is an integral part of the CX1277 design. Sound, innovative acoustical design combined with state of the art digital processing leads to exceptional clarity and precise transient response, even at very high sound pressure levels. The required digital signal processing can be provided by one of many supported platforms.

The CX1277 is particularly effective in systems where targeted pattern control is desirable, and is an excellent solution for high fidelity, foreground distributed systems. Its unique shape and compact size complements many architectural styles, which facilitates acceptance by interior designers and architects.

This makes it the perfect choice for houses of worship, theaters, restaurants, transportation facilities, theme parks, and more.

### Performance Specifications<sup>1</sup>

#### Operating Mode

Single-amplified w/ DSP

#### Operating Range<sup>2</sup>

69 Hz to 18 kHz

#### Nominal Beamwidth

75° x 75°

#### Transducers

HF/LF: Coaxial 3.0" titanium diaphragm compression driver; 12.0" woofer, 3.0" voice coil; single neodymium magnet

#### Power Handling @ Nominal Impedance<sup>3</sup>

57 V / 400 W @ 8 Ω

#### Nominal Sensitivity @ Input Voltage<sup>4</sup> (whole space)

104 dB @ 2.83 V

#### Nominal Maximum SPL (peak / continuous)

136 dB / 130 dB

#### Equalized Sensitivity @ Input Voltage<sup>5</sup>

98 dB @ 2.83 V

#### Equalized Maximum SPL<sup>6</sup> (peak / continuous)

130 dB / 124 dB

#### Recommended Power Amplifier

400 W to 800 W @ 8 Ω

### Physical Specifications

#### Connections

(2) Neutrik NL4 Speakon

Pin 1+/-: Full Range

Pin 2+/-: NC

#### Mounting / Suspension Points

(12) M10 eye bolt angle points, (2) M10 yoke points

#### Dimensions / Weight

See page 5

#### Finish

Black painted enclosure w/ matte black grille, or

White painted enclosure w/ matte white grille

### Options

CX12 Series U Bracket [YK1811], Terminal strip input, Custom color finish, Weather-resistant (WR) enclosure



Axial Sensitivity (dB SPL, 2.83 V @ 1 m)<sup>7,8</sup>

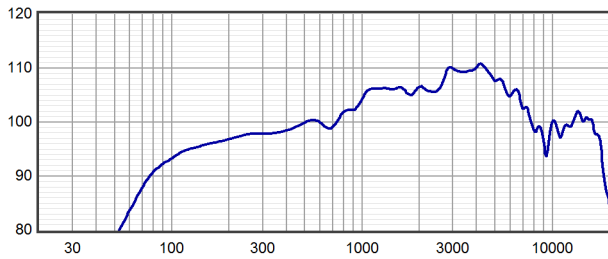

Horizontal Off Axis Response<sup>7,11</sup>

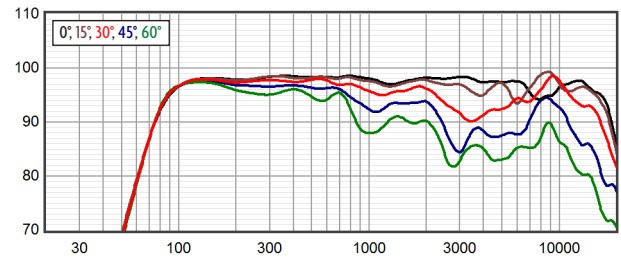

Axial Processed Response (dB)<sup>7,9</sup>

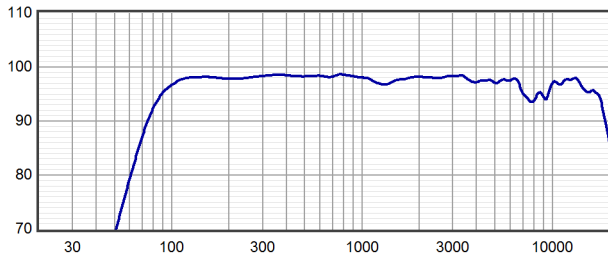

Vertical Off Axis Response<sup>7,11</sup>

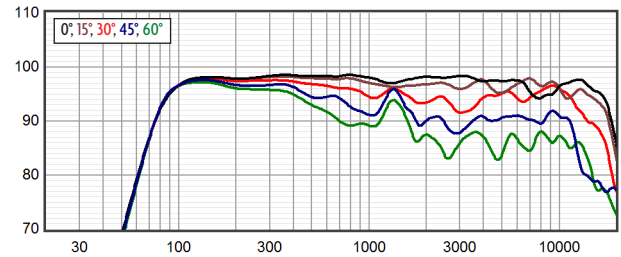

Axial Processed Phase Response (degrees)<sup>7,10</sup>

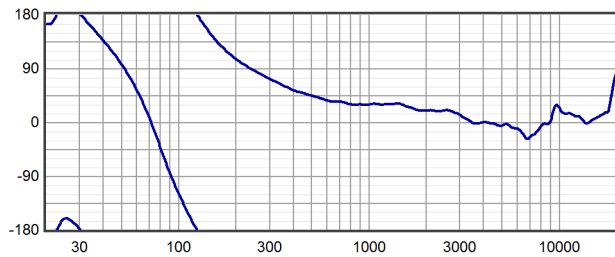

Beamwidth<sup>7,12</sup>

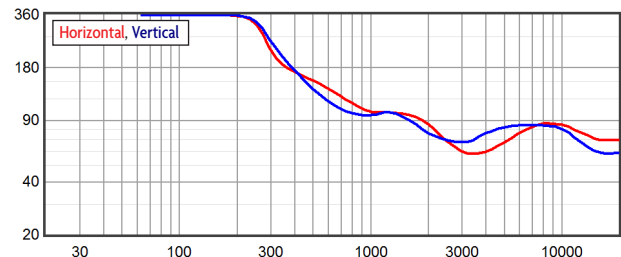

Impedance (ohms)

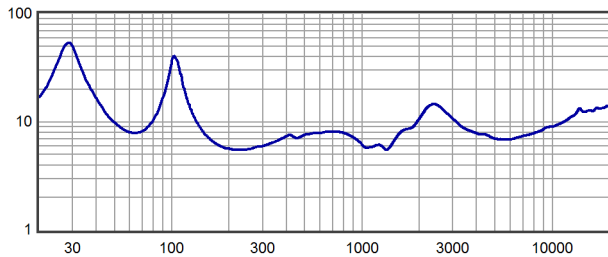

Directivity Index (dB)<sup>13</sup>

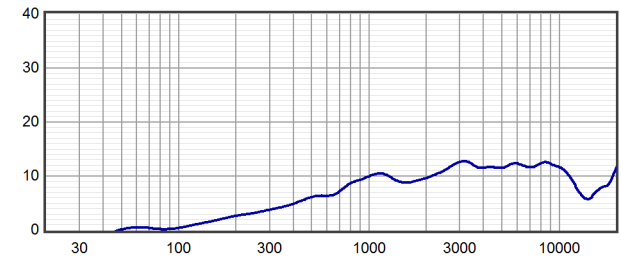



Horizontal Polar Response (30 dB Scale, 6 dB per Major Division)

100 Hz  
125 Hz  
160 Hz  
200 Hz

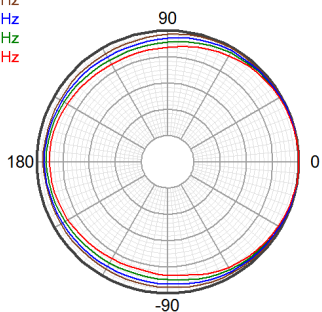

250 Hz  
315 Hz  
400 Hz  
500 Hz

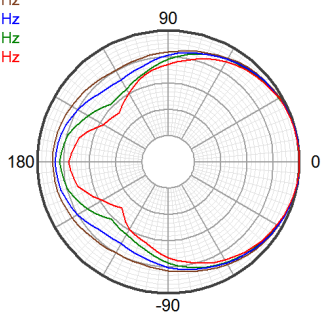

630 Hz  
800 Hz  
1000 Hz  
1250 Hz

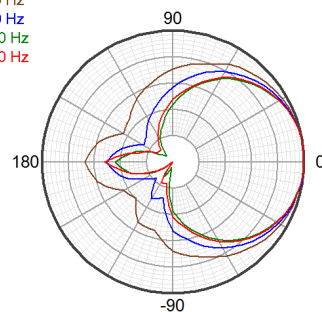

1600 Hz  
2000 Hz  
2500 Hz  
3150 Hz

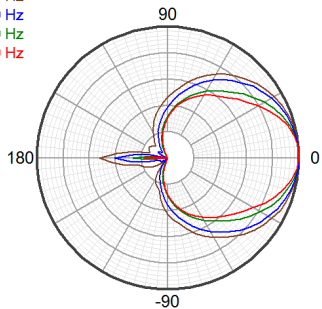

4000 Hz  
5000 Hz  
6300 Hz  
8000 Hz

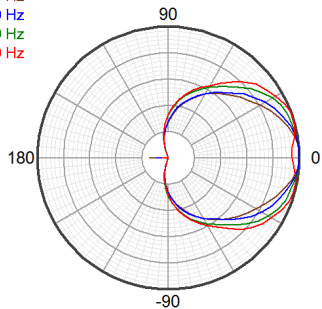

10000 Hz  
12500 Hz  
16000 Hz

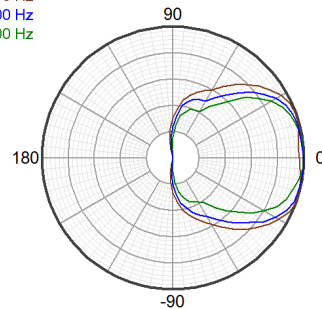

Vertical Polar Response (30 dB Scale, 6 dB per Major Division)

100 Hz  
125 Hz  
160 Hz  
200 Hz

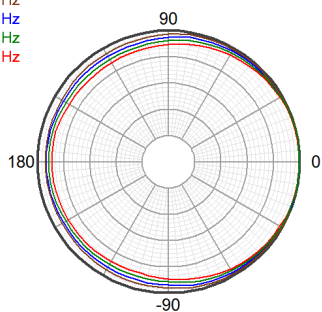

250 Hz  
315 Hz  
400 Hz  
500 Hz

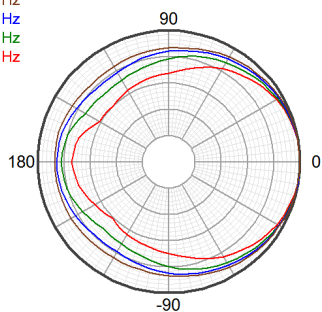

630 Hz  
800 Hz  
1000 Hz  
1250 Hz

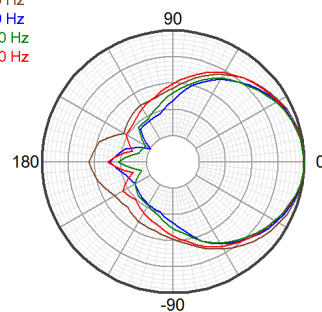

1600 Hz  
2000 Hz  
2500 Hz  
3150 Hz

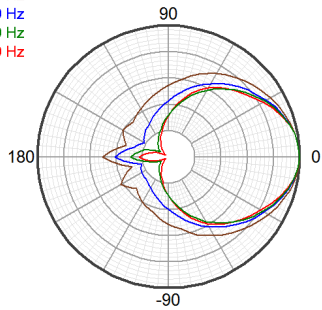

4000 Hz  
5000 Hz  
6300 Hz  
8000 Hz

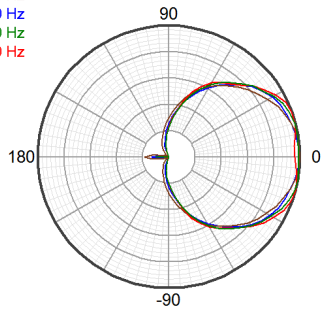

10000 Hz  
12500 Hz  
16000 Hz

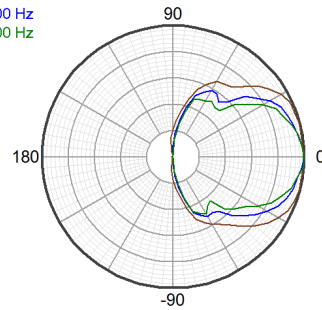



### Technologies

The proprietary horns employed in the CX Series represent a modern digital-signal-processing-aware update to the traditional horn-loaded coaxial loudspeaker concept. The well-known benefits of the coaxial approach have been realized without the familiar shortcomings of historical designs. Fulcrum Acoustic's **Temporal Equalization™ (TQ™)** digital signal processing techniques eliminate midrange colorations and high frequency harshness while producing a smooth, seamless coverage pattern through the crossover range. In fact, the coaxial transducers were designed from the ground up to take advantage of the unique capabilities of TQ™.

The coaxial transducer in the CX1277 includes a 3 inch diaphragm compression driver. The large diaphragm area permits the compression driver to operate at frequencies too low for smaller

compression drivers to handle. This allows the high frequency horn to smooth the polar response of the low frequency section in the frequency range where the horn would otherwise cause shadowing. It also allows the compression driver to produce extreme sound pressure levels with an effortless sonic character.

The coaxial woofer's large radiating surface works in conjunction with the HF horn to improve directional control at the bottom of the horn's operating range, increasing directional control beyond what can be accomplished by the horn alone. The coaxial transducer's compact, neodymium magnet not only minimizes weight, but also allows very tight spacing between the compression driver and woofer voice coils. The delay between the driver outputs is thereby minimized, which allows the coaxial device to work well with a passive crossover.

### Connection Diagram

2-way, Single-Amp

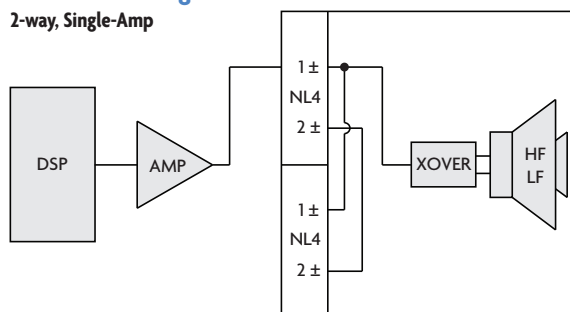

### Mechanical Specification Drawings

2D and 3D DXF dimensional drawings are available for download at [www.fulcrum-acoustic.com/support](http://www.fulcrum-acoustic.com/support).

### Notes

- <sup>1</sup> **Performance Specifications** All acoustic specifications rounded to nearest whole number. External DSP with Fulcrum Acoustic-provided settings is required to achieve the specified performance.
- <sup>2</sup> **Operating Range** The frequency range within which the processed response is within 10 dB of the average.
- <sup>3</sup> **Power Handling** Based on the AES power handling of the transducers.
- <sup>4</sup> **Nominal Sensitivity** The 1-meter-referenced SPL produced by a 1 watt band limited pink noise signal, with no processing applied.
- <sup>5</sup> **Equalized Sensitivity** The 1-meter-referenced SPL produced when an EIA-426-B signal is applied to an equalized loudspeaker system, at a level which produces a total power of 1 watt, in sum, to the loudspeaker subsections.
- <sup>6</sup> **Equalized Maximum SPL** The 1-meter-referenced SPL produced when an EIA-426-B signal is applied to an equalized loudspeaker system, at a level which drives at least one subsection to its rated power.
- <sup>7</sup> **Resolution** All response graphs are subjected to 1/6 octave cepstral smoothing with a gaussian weighting function.
- <sup>8</sup> **Axial Sensitivity** The SPL plotted against frequency for a 1 watt swept sine wave, referenced to 1 m with no signal processing.
- <sup>9</sup> **Axial Processed Response** The axial magnitude response with recommended signal processing applied.
- <sup>10</sup> **Axial Processed Phase Response** The axial phase response with recommended signal processing applied, and latency removed.
- <sup>11</sup> **Horizontal / Vertical Off Axis Responses** The magnitude response at various angles off axis, with recommended signal processing applied.
- <sup>12</sup> **Beamwidth** The angle between the -6 dB points in a loudspeaker's polar response.
- <sup>13</sup> **Directivity Index (Di)** The ratio of the on-axis sound pressure squared to the spherical average of the sound pressure squared at a particular frequency expressed in dB. To convert the directivity index to directivity factor (Q) use the formula  $10^{Di/10}$ .



product specification

Notes:

1. Net Weight = Approx. 32.0 lb / 14.5 kg
2. Ship Weight = Approx. 40.0 lb / 18.1 kg
3. Symbol = M10 eye bolt angle point
4. Symbol = M10 nut plate
5. Symbol = CoG
7. Drawing representative of:  
CX1226, CX1265, CX1277, CX1295

REVISIONS		
REV	DESCRIPTION	APPR / DATE
5	SWAP INPUT & ID LABEL	RAF 10/21/09
6	ADD SHIPPING WEIGHT	RAF 12/7/11
7	DMNIMOUNT TO 'THIRD PARTY' IN NOTE 5	RAF 1/13/12
8	CHANGE DRAWING NAME TO 'CX12 SERIES'	RAF 5/9/12
9	ADD 'CX1226' TO NOTE 7	RAF 4/22/13
10	REMOVE PAN/TILT MOUNT POINTS	RAF 7/28/16

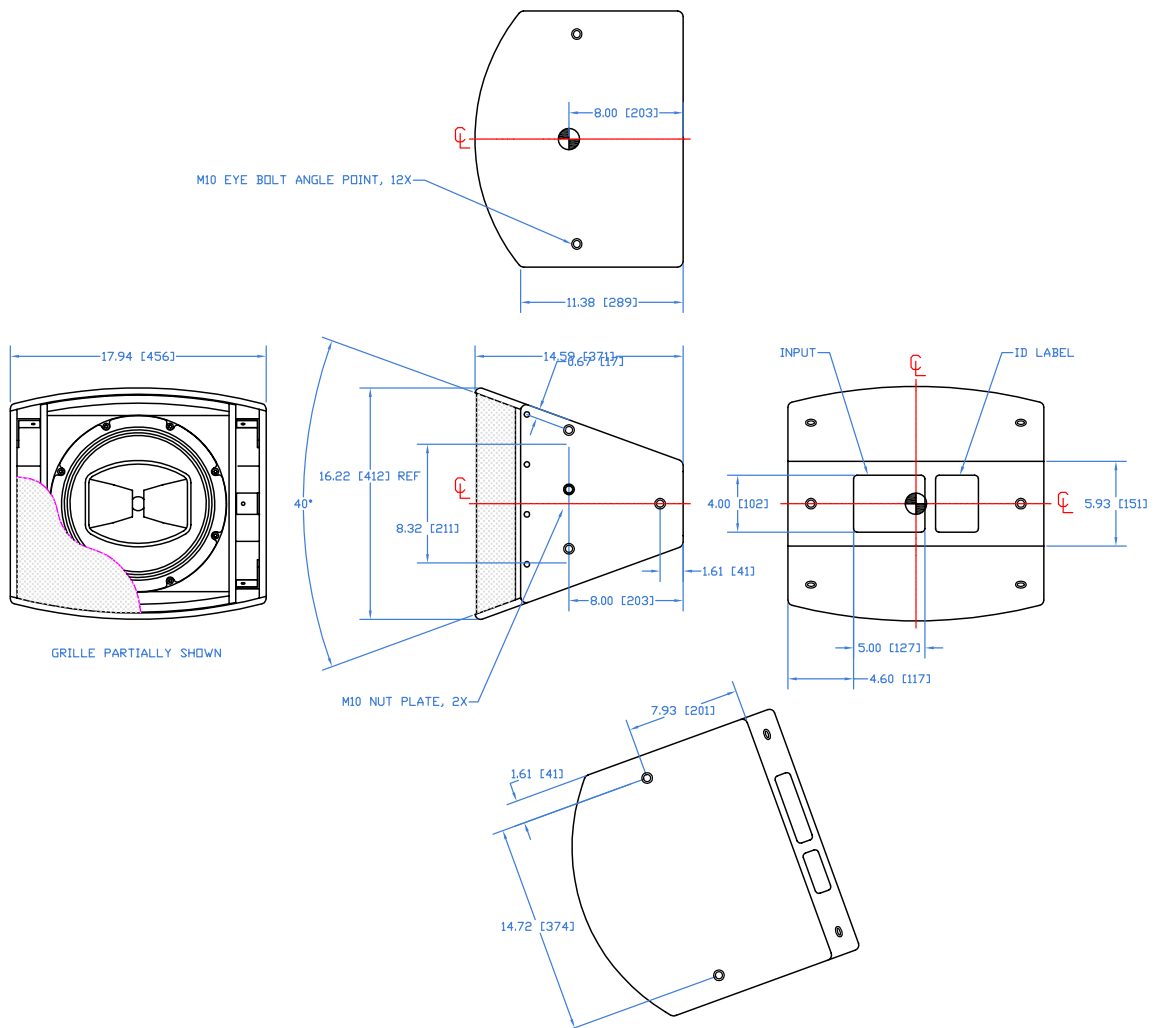

<p>THIRD ANGLE PROJECTION</p>	<p>UNLESS OTHERWISE SPECIFIED: ALL DIMENSIONS ARE IN INCHES</p> <p>TOLERANCE IN INCHES .XX±.015 .XXX±.005 FRACTIONS ±1/32 ANGLES ±1/2°</p> <p>(X.XX) = REF DIMS NO TOLERANCE IMPLIED</p> <p>TSC = THEORETICAL SHARP CORNER</p> <p>DIMENSIONS ACROSS CENTERLINES TO BE SYMMETRICAL</p>	<p>STATUS RELEASED</p>		<p>FULCRUM ACOUSTIC, LLC 670 LINWOOD AVE, LINWOOD, MA 01525 USA</p>	
		<p>APPROVALS</p> <p>DRAWN: DWG</p> <p>CHECKED: RAF</p> <p>DES ENG:</p> <p>MFG ENG:</p>	<p>DATE</p> <p>2/10/09</p> <p>6/12/09</p>	<p>TITLE: Mechanical Spec, CX12 Series</p>	
<p>THIS DRAWING IS THE PROPERTY OF FULCRUM ACOUSTIC, AND SHALL NOT BE COPIED, REPRODUCED, OR USED AS THE BASIS FOR MANUFACTURE OR SALE OF APPARATUS WITHOUT WRITTEN AUTHORIZATION. DO NOT SCALE DRAWING.</p>		<p>DWG. NO. 820-100-014</p>		<p>SCALE: 1:12</p> <p>REV 10</p>	

Drawing is reduced. Do not scale.



product specification, weather-resistant (WR) version

**Notes:**

1. Net Weight = Approx. 43.5 lb / 19.7 kg
2. Ship Weight = Approx. 51.5 lb / 23.4 kg
3. Symbol = M10 eye bolt angle point
4. Symbol = M10 nut plate
5. Symbol = CoG
6. Drawing representative of:  
CX1226-WR, CX1265-WR,  
CX1277-WR, CX1295-WR
7. Exterior dimensions are based on fiberglass thickness of 0.125 inch. Actual thickness may vary by ±0.06 inches.

**REVISIONS**

REV	DESCRIPTION	APPR / DATE
1	NEW ISSUE, WR VERSION OF 820-100-014	
2	GENERAL DRAWING UPDATES	11/19/15
3	REMOVE PAN/TILT MOUNT POINTS	7/28/16

THIRD ANGLE PROJECTION

THIS DRAWING IS THE PROPERTY OF FULCRUM ACOUSTIC, AND SHALL NOT BE COPIED, REPRODUCED, OR USED AS THE BASIS FOR MANUFACTURE OR SALE OF APPARATUS WITHOUT WRITTEN AUTHORIZATION. DO NOT SCALE DRAWING.

UNLESS OTHERWISE SPECIFIED:  
ALL DIMENSIONS ARE IN INCHES

TOLERANCE IN INCHES  
.X±.1 .XX±.015 .XXX±.005  
FRACTIONS ±1/32  
ANGLES ±1/2°

(X.XX) = REF DIMS NO TOLERANCE IMPLIED

TSC = THEORETICAL SHARP CORNER

DIMENSIONS ACROSS CENTERLINES TO BE SYMMETRICAL

STATUS: **RELEASED**

APPROVALS	DATE
DRAWN: DWG	3/02/10
CHECKED:	
DES ENG:	
MFG ENG:	

FULCRUM ACOUSTIC, LLC  
670 LINWOOD AVE., LINWOOD, MA 01525 USA

TITLE: **Mechanical Spec,  
CX12 Series - WR**

A SHEET 1 OF 1 SCALE: 1:12

DWG. NO. 820-100-031 REV 3

Drawing is reduced. Do not scale.

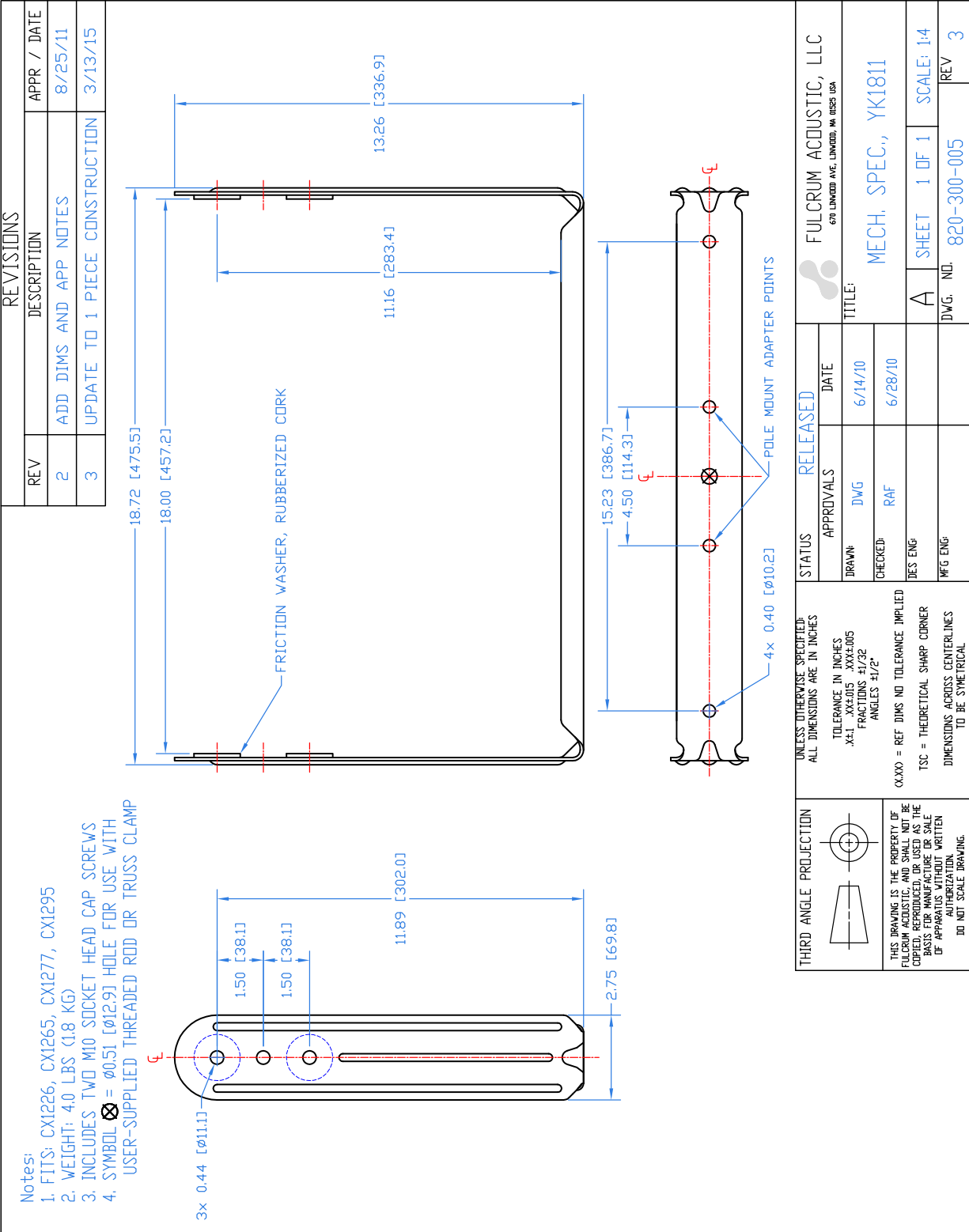

Drawing is reduced. Do not scale.