



RM22ac

Self-Powered Dual 12 inch Coaxial Reference Monitor

reference
MONITOR



Overview

The RM22ac is a bi-amplified, 3-way coaxial reference monitor that provides the accuracy, pristine imaging and precise transient response required of a studio monitor but with the directional control, power handling and output capability required in larger spaces. The coaxial and low frequency transducers are mounted in independent, asymmetrical chambers designed to minimize standing waves. In addition, the internal volume and porting are optimized for extended low frequency response. This combination results in a highly articulate low mid transient response and surprisingly visceral low frequency extension. Its shallow enclosure includes numerous M10 mounting points, while its rotatable 90° x 45° coaxial transducer supports either vertical or horizontal orientation.

Sound, innovative acoustical design combined with on-board **TQ™**, Level 1 processing provides exceptional clarity and stability, and precise transient response even at very high sound pressure levels. Four back panel selectable presets optimize the response for either vertical or horizontal orientations, whole or half space. A full complement of input filters and delay, as well as signal levels and amplifier status, may be accessed via Ethernet, using **Armonia Pro Audio Suite™** control software. In addition, a pre-output EQ stage is available for programming custom presets. These presets may be saved and later recalled using the back panel Preset Select button or software.

The RM22ac's robust transducers are powered by two 1050 watt amplifier channels, designed and manufactured in Italy by Powersoft. Powersoft amplifiers incorporate state-of-the-art Class-D technology to produce extremely high efficiency, low noise, and low intermodulation distortion in compact and lightweight packages.

The RM22ac is primarily intended for use as a mid- to far-field monitor in recording studios and A/V production suites; but it is also an ideal choice for cinemas, museum exhibit spaces, multimedia presentation facilities, boardrooms, and high end home theaters: any environment in which pristine audio quality is desired and a protective grille is not necessary.

Performance Specifications¹

Operating Mode

Self-Powered, w/ On-Board DSP

Operating Range²

37 Hz to 20 kHz

Nominal Beamwidth (rotatable)

90° x 45°

Transducers

LF: 12.0" ceramic magnet woofer, 4.0" voice coil
HF/LF: Coaxial 3.0" titanium diaphragm compression driver;
12.0" woofer, 3.0" voice coil; single neodymium magnet

Power Handling @ Nominal Impedance³

LF: 75 V / 700 W @ 8 Ω

HF/LF: 57 V / 400 W @ 8 Ω

Nominal Sensitivity @ Input Voltage⁴ (whole space)

LF: 91 dB @ 2.83 V

HF/LF: 105 dB @ 2.83 V

Nominal Maximum Continuous SPL

LF: 117 dB

HF/LF: 133 dB

Equalized Sensitivity @ Input Voltage⁵

95 dB @ 2.83 V

Equalized Maximum SPL⁶

122 dB

Physical Specifications

Connections

(2) Neutrik NL4 Speakon

Pin 1+/-: LF

Pin 2+/-: HF/LF

Mounting / Suspension Points

(12) M10 eye bolt angle points, (2) M10 yoke points

Dimensions / Weight

See page 6

Finish

Black or white painted enclosure

Options

Custom color finish



Axial Sensitivity (dB SPL, 2.83 V @ 1 m)^{7,8}

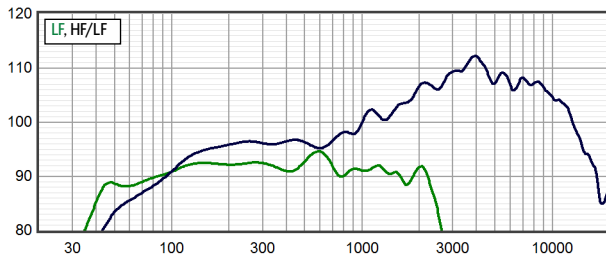

Horizontal Off Axis Response^{7,11}

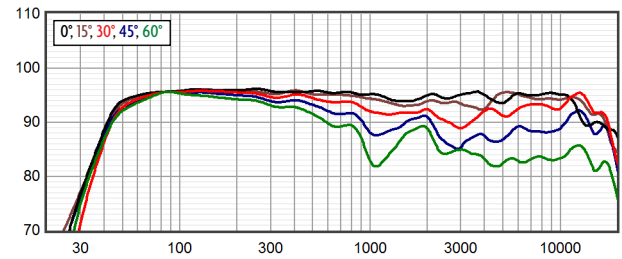

Axial Processed Response (dB)^{7,9}

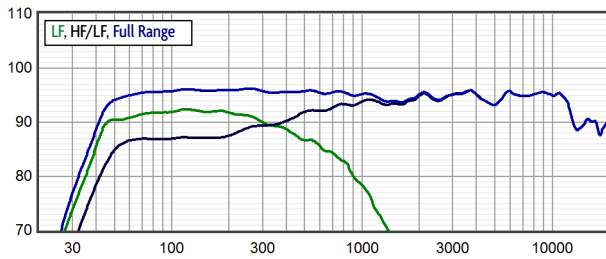

Vertical Off Axis Response^{7,11}

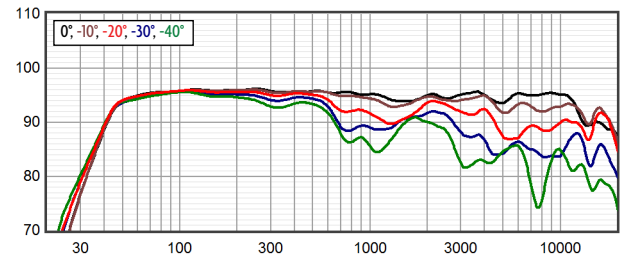

Axial Processed Phase Response (degrees)^{7,10}

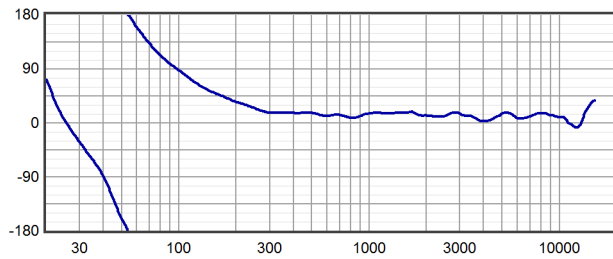

Beamwidth^{7,12}

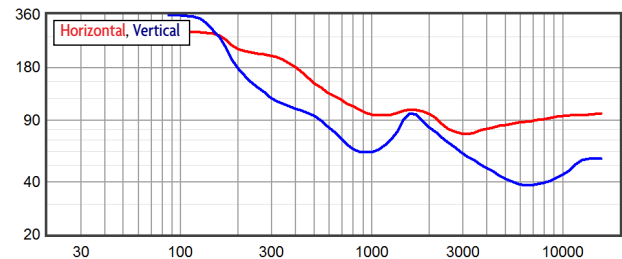

Impedance (ohms)

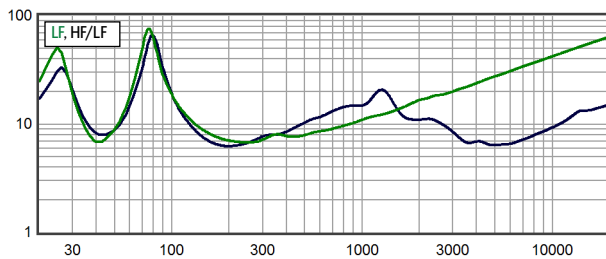

Directivity Index (dB)¹³

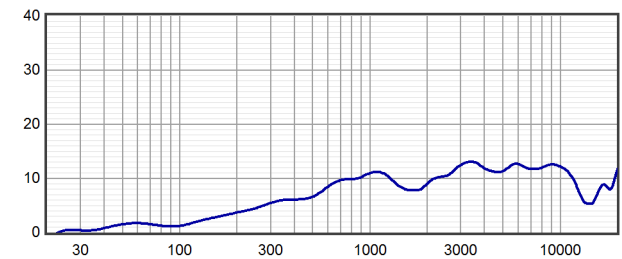



Horizontal Polar Response (30 dB Scale, 6 dB per Major Division)

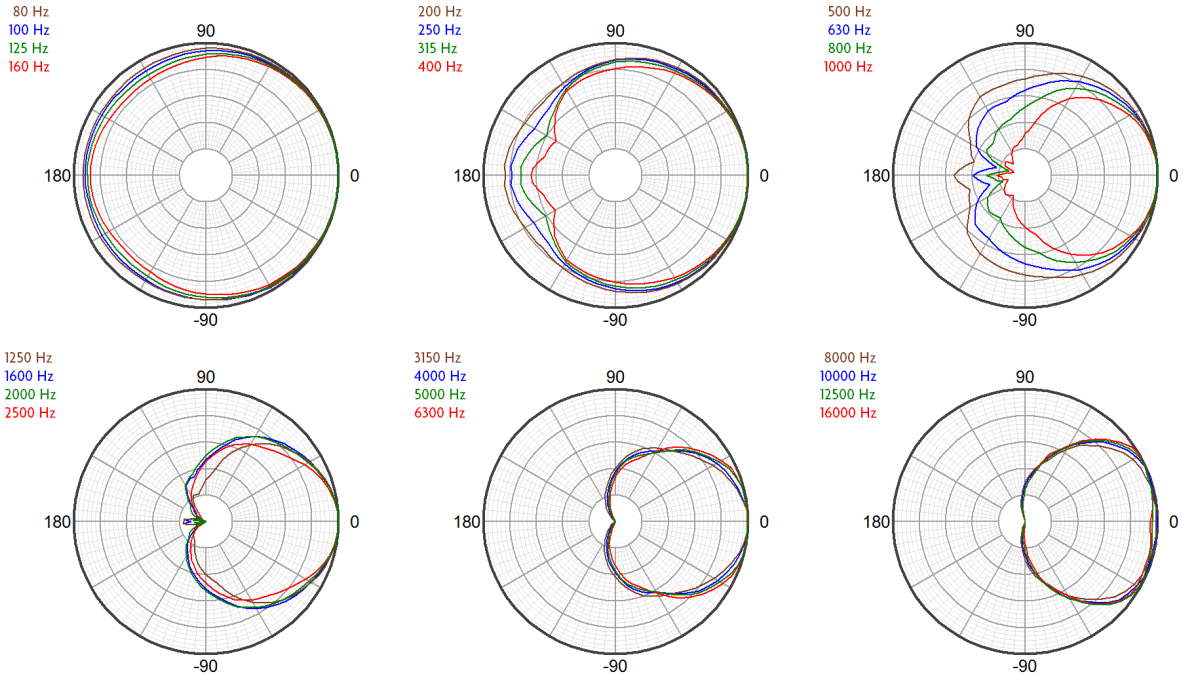

Vertical Polar Response (30 dB Scale, 6 dB per Major Division)

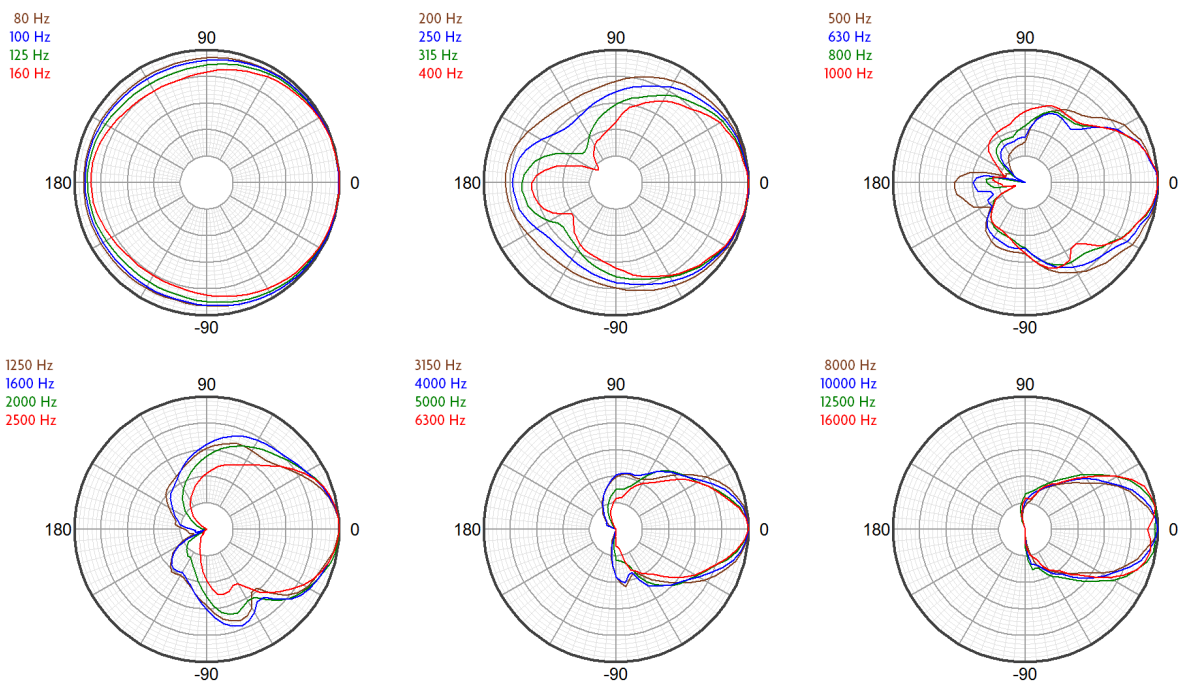



Technologies

The RM series represents a modern digital-signal-processing-aware update to the traditional horn-loaded coaxial monitor concept. The well-known benefits of the coaxial approach have been realized without the familiar shortcomings of historical designs. Fulcrum **Temporal Equalization™ (TQ™)** digital signal processing techniques provide precise transient response and accurate voicing, while ensuring smooth, seamless coverage through the crossover range. In fact, the coaxial transducers were designed from the ground up to take advantage of the unique capabilities of TQ™.

The coaxial transducer in the RM22ac includes a 3 inch diaphragm compression driver. The large diaphragm area permits the compression driver to operate at frequencies too low for smaller compression drivers to handle. This allows the high frequency horn to smooth the directional response of the low frequency section in the frequency range where the horn would otherwise cause shadowing. It also allows the compression driver to produce extreme sound pressure levels with an effortless sonic character.

The coaxial woofer's large radiating surface works in conjunction with the high frequency horn to improve directional control at the low frequency end of the horn's operating range, increasing directional control beyond what can be accomplished by the horn alone.

Input Panel

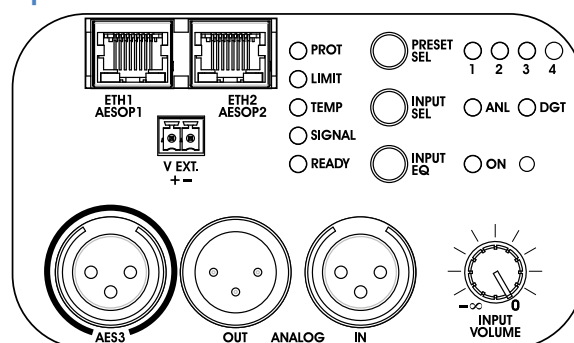

RM22ac Presets

Preset 1	Vertical Orientation, Whole Space
Preset 2	Vertical Orientation, Half Space
Preset 3	Horizontal Orientation, Whole Space
Preset 4	Horizontal Orientation, Half Space

Presets 5-8 user-programmable in **Armonia Pro Audio Suite™** control software. Press and hold rear panel Preset Select button 3 seconds to access these presets.

Mechanical Specification Drawings

2D and 3D DXF dimensional drawings are available for download at www.fulcrum-acoustic.com/support.

Notes

- ¹ **Performance Specifications** All acoustic specifications rounded to nearest whole number. External DSP with Fulcrum Acoustic-provided settings is required to achieve the specified performance.
- ² **Operating Range** The frequency range within which the processed response is within 10 dB of the average.
- ³ **Power Handling** Based on the AES power handling of the transducers.
- ⁴ **Nominal Sensitivity** The 1-meter-referenced SPL produced by a 1 watt band limited pink noise signal, with no processing applied.
- ⁵ **Equalized Sensitivity** The 1-meter-referenced SPL produced when an EIA-426-B signal is applied to an equalized loudspeaker system, at a level which produces a total power of 1 watt, in sum, to the loudspeaker subsections.
- ⁶ **Equalized Maximum SPL** The 1-meter-referenced SPL produced when an EIA-426-B signal is applied to an equalized loudspeaker system, at a level which drives at least one subsection to its rated power.
- ⁷ **Resolution** All response graphs are subjected to 1/6 octave cepstral smoothing with a gaussian weighting function.
- ⁸ **Axial Sensitivity** The SPL plotted against frequency for a 1 watt swept sine wave, referenced to 1 m with no signal processing.
- ⁹ **Axial Processed Response** The axial magnitude response with recommended signal processing applied.
- ¹⁰ **Axial Processed Phase Response** The axial phase response with recommended signal processing applied, and latency removed.
- ¹¹ **Horizontal / Vertical Off Axis Responses** The magnitude response at various angles off axis, with recommended signal processing applied.
- ¹² **Beamwidth** The angle between the -6 dB points in a loudspeaker's polar response.
- ¹³ **Directivity Index (Di)** The ratio of the on-axis sound pressure squared to the spherical average of the sound pressure squared at a particular frequency expressed in dB. To convert the directivity index to directivity factor (Q) use the formula $10^{Di/10}$.



product specification

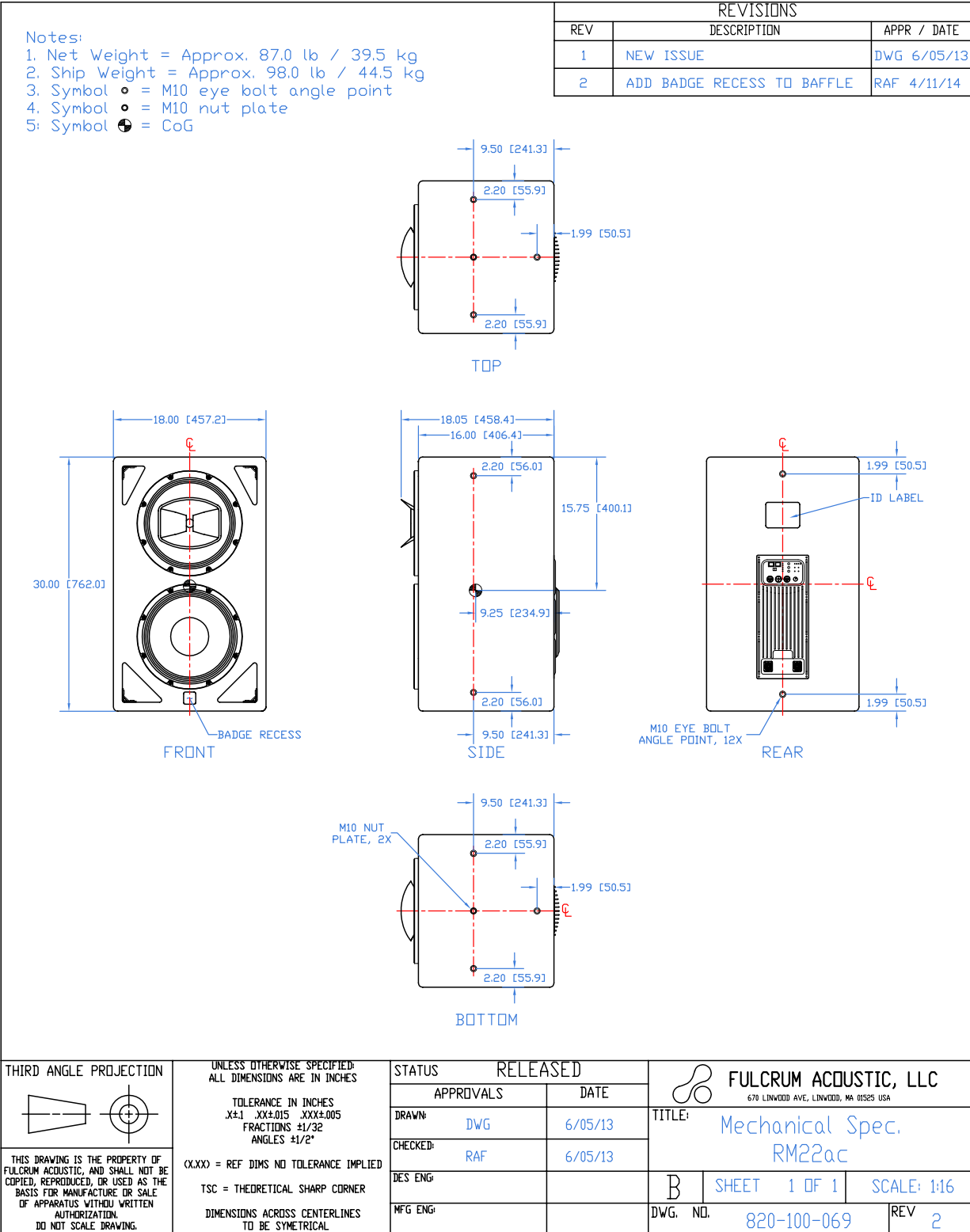

Drawing is reduced. Do not scale.