



RX599

5.25 inch Coaxial Loudspeaker

tq install™
SERIES



Overview

The RX599 is a high efficiency, high fidelity coaxial loudspeaker that provides output capability typical of a much larger loudspeaker. The transducer's high efficiency and horn-loaded HF compression driver give the RX599 a surprisingly high output-to-size ratio, and its broad 90° x 90° coverage is particularly effective in close quarters. The RX599's compact enclosure may be mounted close to walls or ceilings, under balconies, or along a stage front with minimal effect on sight lines. Its small size also allows it to be readily concealed within a venue's architecture when the loudspeaker must be hidden from view.

Fulcrum Acoustic's **TQ™** processing is an integral part of the RX599 design. Sound, innovative acoustical design combined with state of the art digital processing leads to exceptional clarity and precise transient response, even at very high sound pressure levels. The required digital signal processing can be provided by one of many supported platforms.

The RX599 is an excellent option any time moderately high SPLs are required but limited space is available. Spoken word sounds very natural, and the coaxial design assures that this remains so even off-axis. Low frequency extension to 100 Hz enables it to integrate well with subwoofers for full range music reproduction. The RX599 is a perfect choice for delay fill, background music, and speech reproduction systems, which makes it ideal for houses of worship, theaters, restaurants, nightclubs, museum kiosks, theme parks, and more.

Performance Specifications¹

Operating Mode

Single-amplified w/ DSP

Operating Range²

100 Hz to 20 kHz

Nominal Beamwidth

90° x 90°

Transducers

HF/LF: Coaxial 1.0" diaphragm compression driver, neodymium magnet; 5.25" woofer, 1.7" voice coil, ceramic magnet

Power Handling @ Nominal Impedance³

49 V / 150 W @ 16 Ω

Nominal Sensitivity @ Input Voltage⁴ (whole space)

93 dB @ 4.00 V

Nominal Maximum SPL (peak / continuous)

121 dB / 115 dB

Equalized Sensitivity @ Input Voltage⁵

85 dB @ 4.00 V

Equalized Maximum SPL⁶ (peak / continuous)

113 dB / 107 dB

Recommended Power Amplifier

150 W to 300 W @ 16 Ω

Physical Specifications

Connections

Terminal strip input

Mounting / Suspension Points

- (2) M6 yoke points,
- (2) M6 nut plates for third-party pan/tilt mounts

Dimensions / Weight

See page 5

Finish

Black painted enclosure w/ matte black grille, or
White painted enclosure w/ matte white grille

Options

RX599 U Bracket [YK905], Custom color finish,
Weather-resistant (WR) enclosure,
70 V multi-tap transformer (RX599-MT30)



Axial Sensitivity (dB SPL, 4.00 V @ 1 m)^{7,8}

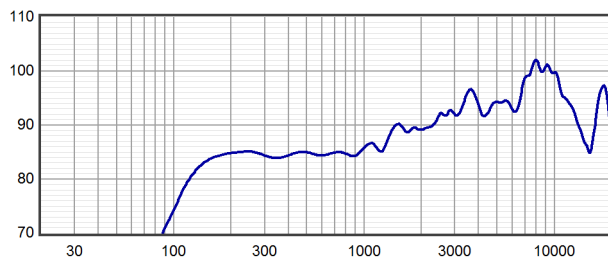

Horizontal Off Axis Response^{7,11}

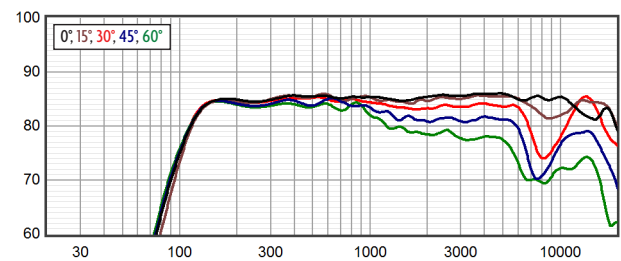

Axial Processed Response (dB)^{7,9}

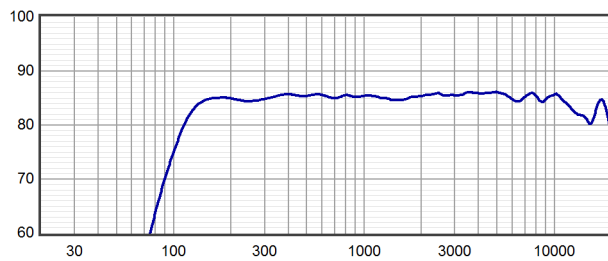

Vertical Off Axis Response^{7,11}

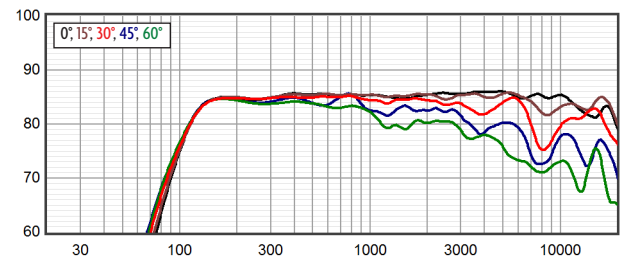

Axial Processed Phase Response (degrees)^{7,10}

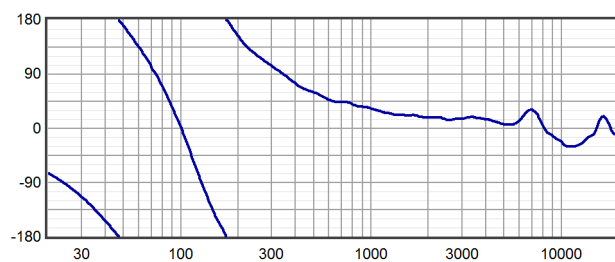

Beamwidth^{7,12}

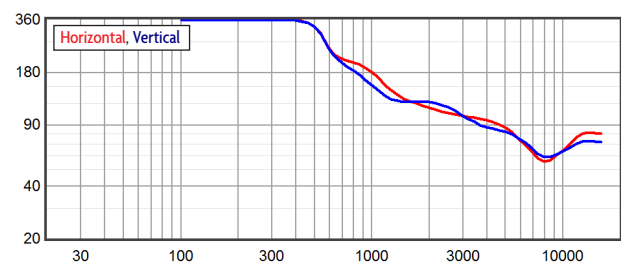

Impedance (ohms)

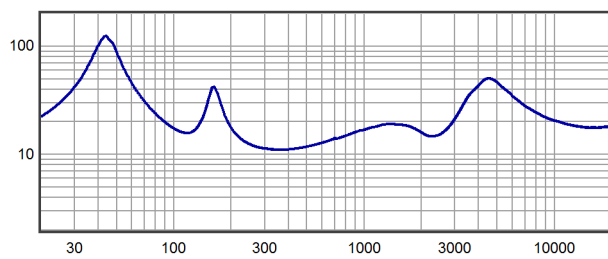

Directivity Index (dB)¹³

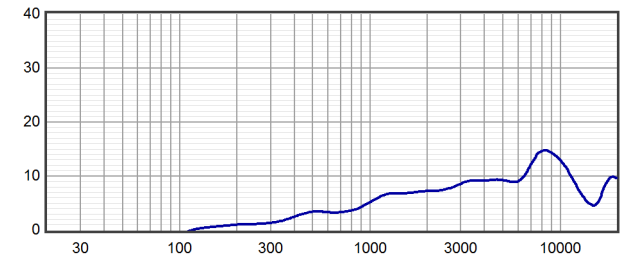



Horizontal Polar Response (30 dB Scale, 6 dB per Major Division)

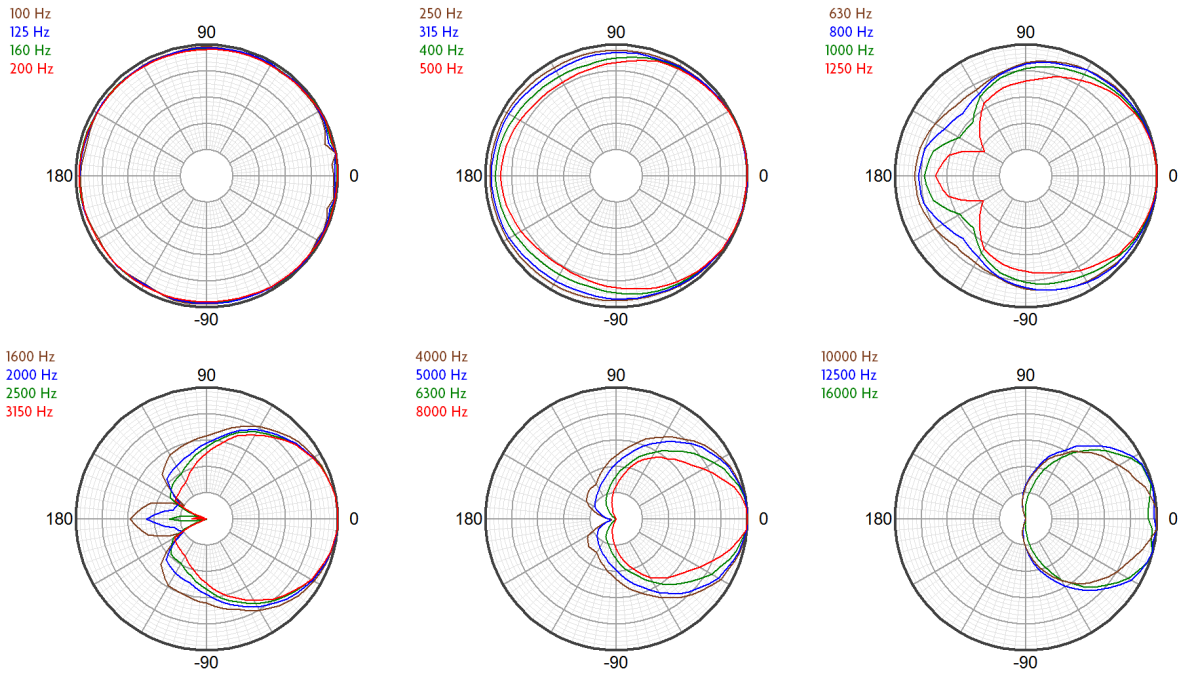

Vertical Polar Response (30 dB Scale, 6 dB per Major Division)

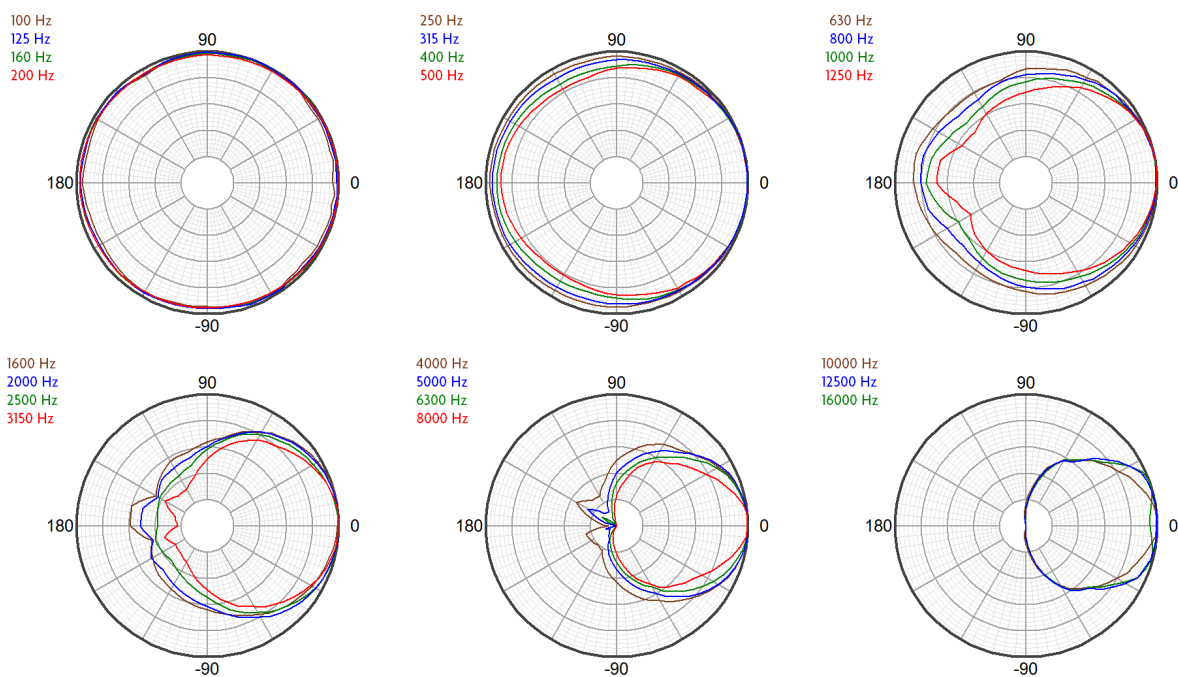



Technologies

The RX599 includes a powerful ferrite-based low frequency section and a tightly integrated 1 inch neodymium compression driver, which positions the compression driver diaphragm very close to the woofer voice coil. This allows the system to maintain coherent summation and provide consistent off axis response through a passive crossover, allowing it to be powered with a single amplifier channel.

Connection Diagram

2-way, Single-Amp

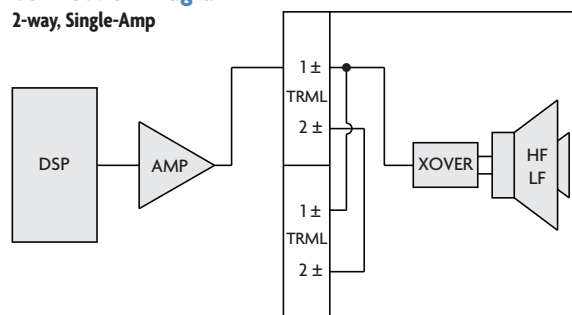

Mechanical Specification Drawings

2D and 3D DXF dimensional drawings are available for download at www.fulcrum-acoustic.com/support.

Notes

- ¹ **Performance Specifications** All acoustic specifications rounded to nearest whole number. External DSP with Fulcrum Acoustic-provided settings is required to achieve the specified performance.
- ² **Operating Range** The frequency range within which the processed response is within 10 dB of the average.
- ³ **Power Handling** Based on the AES power handling of the transducers.
- ⁴ **Nominal Sensitivity** The 1-meter-referenced SPL produced by a 1 watt band limited pink noise signal, with no processing applied.
- ⁵ **Equalized Sensitivity** The 1-meter-referenced SPL produced when an EIA-426-B signal is applied to an equalized loudspeaker system, at a level which produces a total power of 1 watt, in sum, to the loudspeaker subsections.
- ⁶ **Equalized Maximum SPL** The 1-meter-referenced SPL produced when an EIA-426-B signal is applied to an equalized loudspeaker system, at a level which drives at least one subsection to its rated power.
- ⁷ **Resolution** All response graphs are subjected to 1/6 octave cepstral smoothing with a gaussian weighting function.
- ⁸ **Axial Sensitivity** The SPL plotted against frequency for a 1 watt swept sine wave, referenced to 1 m with no signal processing.
- ⁹ **Axial Processed Response** The axial magnitude response with recommended signal processing applied.
- ¹⁰ **Axial Processed Phase Response** The axial phase response with recommended signal processing applied, and latency removed.
- ¹¹ **Horizontal / Vertical Off Axis Responses** The magnitude response at various angles off axis, with recommended signal processing applied.
- ¹² **Beamwidth** The angle between the -6 dB points in a loudspeaker's polar response.
- ¹³ **Directivity Index (Di)** The ratio of the on-axis sound pressure squared to the spherical average of the sound pressure squared at a particular frequency expressed in dB. To convert the directivity index to directivity factor (Q) use the formula $10^{Di/10}$.

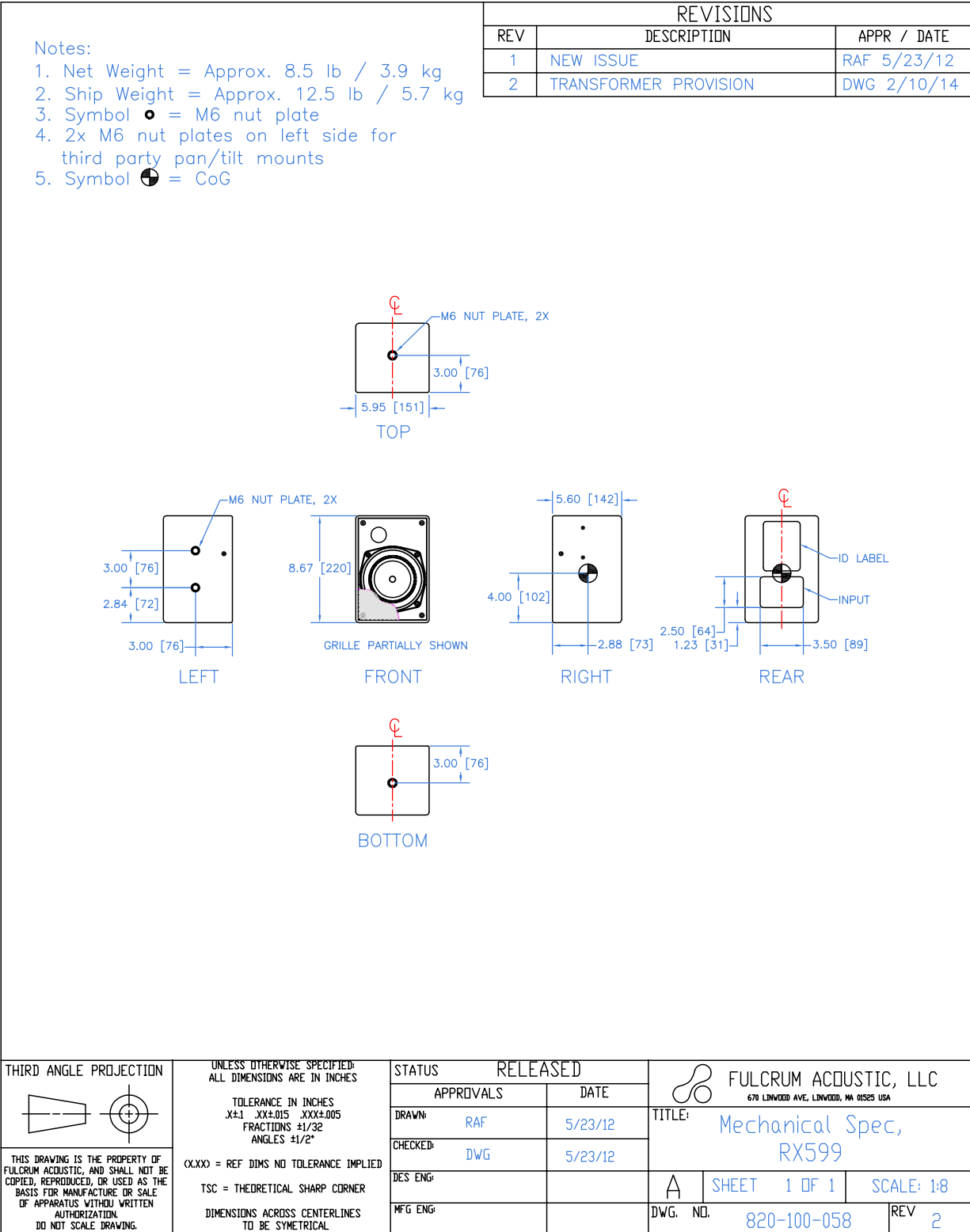

Drawing is reduced. Do not scale.



product specification, weather-resistant (WR) version

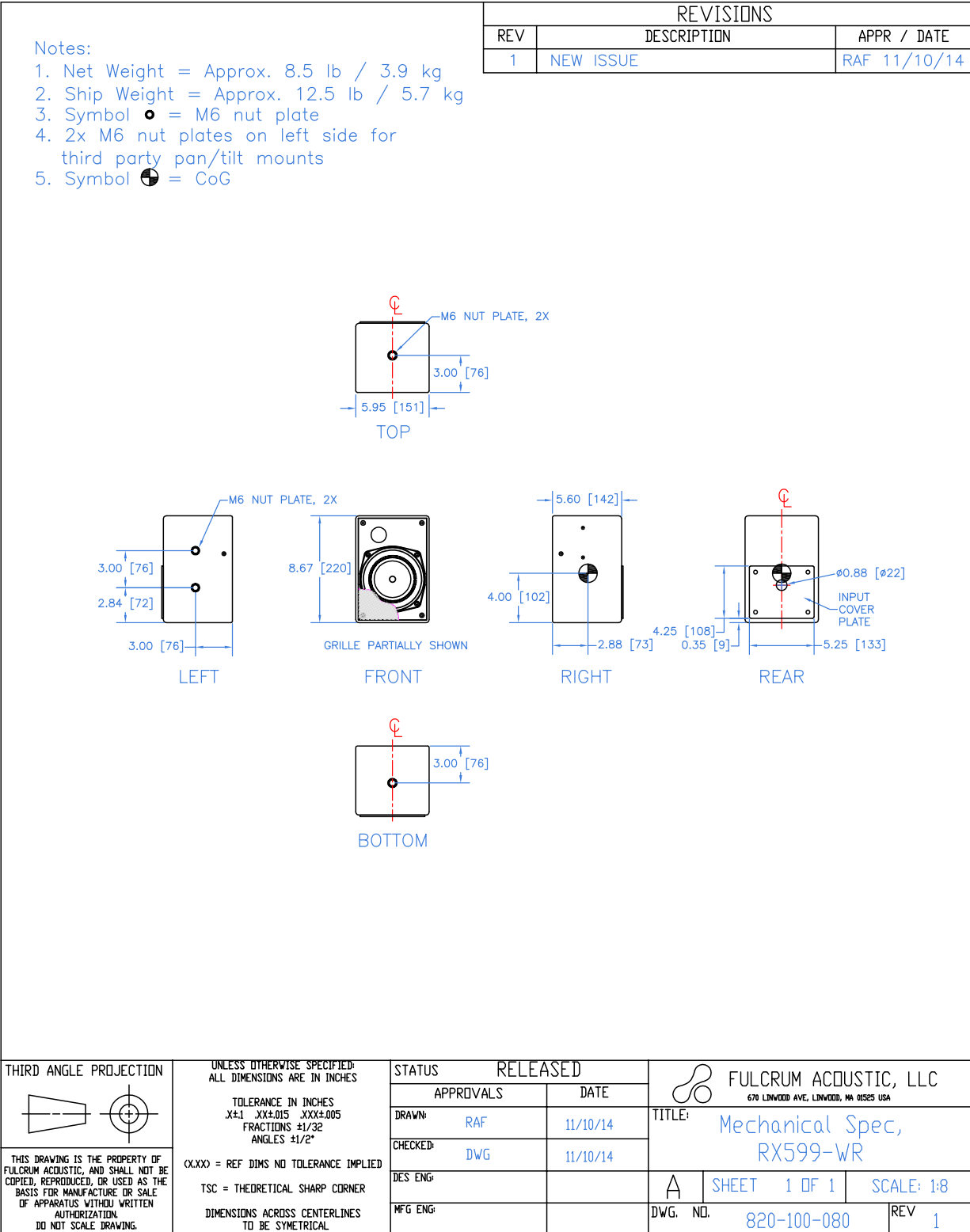

Drawing is reduced. Do not scale.

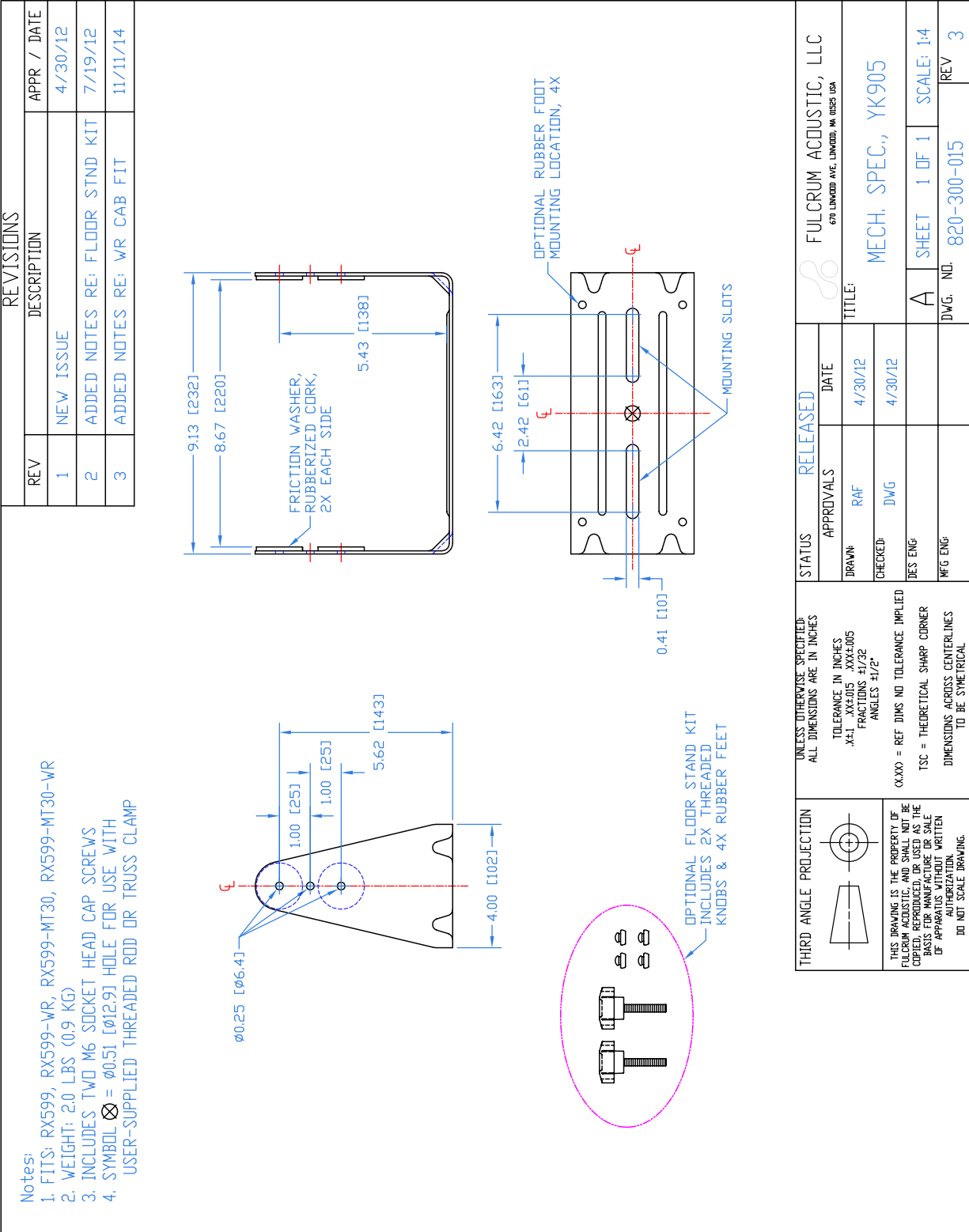

Drawing is reduced. Do not scale.