



fulcrum
ACOUSTIC®

product specification

CX1265

12 inch Coaxial Loudspeaker

tq install™
SERIES



Overview

The CX1265 is a coaxial loudspeaker that provides the output capability and pattern control of a normal 2-way system in a much more compact enclosure. Its coaxial transducer and 60° x 45° horn can be rotated in 45° increments, which allows its coverage to be tailored to an application's requirements. The enclosure's 40° vertically trapezoidal shape allows it to be mounted very close to ceilings with minimal effect on sight lines, and provides the ideal angle for tight-packed vertical arrays.

Fulcrum Acoustic's TQ™ processing is an integral part of the CX1265 design. Sound, innovative acoustical design combined with state of the art digital processing leads to exceptional clarity and precise transient response, even at very high sound pressure levels. The required digital signal processing can be provided by one of many supported platforms.

The CX1265 is particularly effective in systems where targeted pattern control is desirable, and is an excellent solution for high fidelity, foreground distributed systems. Its unique shape and compact size complements many architectural styles, which facilitates acceptance by interior designers and architects. This makes it the perfect choice for houses of worship, theaters, restaurants, transportation facilities, theme parks, and more.

Performance Specifications¹

Operating Mode

Single-amplified w/ DSP

Operating Range²

69 Hz to 20 kHz

Nominal Beamwidth (rotatable)

60° x 45°

Transducers

HF/LF: Coaxial 3.0" titanium diaphragm compression driver; 12.0" woofer, 3.0" voice coil; single neodymium magnet

Power Handling @ Nominal Impedance³

57 V / 400 W @ 8 Ω

Nominal Sensitivity @ Input Voltage⁴ (whole space)

105 dB @ 2.83 V

Nominal Maximum SPL (peak / continuous)

137 dB / 131 dB

Equalized Sensitivity @ Input Voltage⁵

98 dB @ 2.83 V

Equalized Maximum SPL⁶ (peak / continuous)

130 dB / 124 dB

Recommended Power Amplifier

400 W to 800 W @ 8 Ω

Physical Specifications

Connections

(2) Neutrik NL4 Speakon

Pin 1+/-: Full Range

Pin 2+/-: NC

Mounting / Suspension Points

(12) M10 x 1.5 eye bolt angle points, (2) M10 x 1.5 yoke points

Dimensions / Weight

See page 5

Finish

Black painted enclosure w/ matte black grille, or

White painted enclosure w/ matte white grille

Options

YK-CX12 yoke bracket, Terminal strip input, Custom color finish,

Weather-resistant (WR) enclosure & hardware



Axial Sensitivity (dB SPL, 2.83 V @ 1 m)^{7,8}

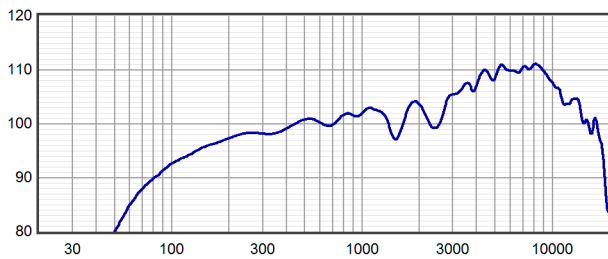

Horizontal Off Axis Response^{7,11}

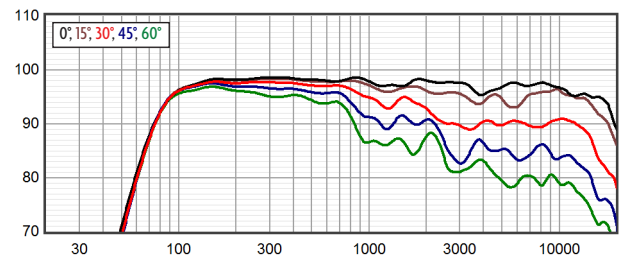

Axial Processed Response (dB)^{7,9}

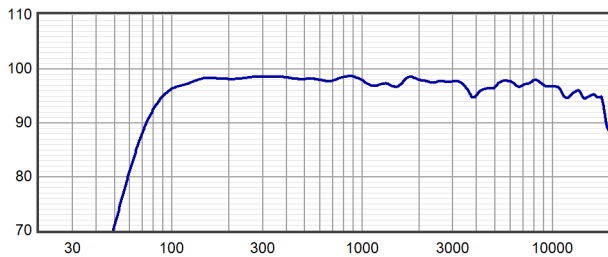

Vertical Off Axis Response^{7,11}

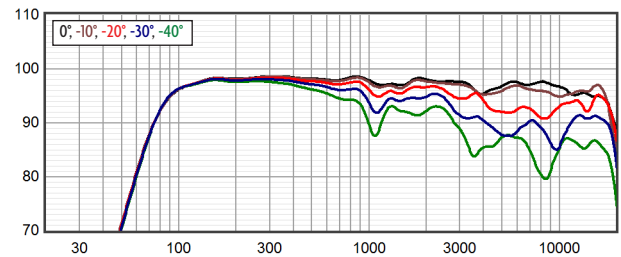

Axial Processed Phase Response (degrees)^{7,10}

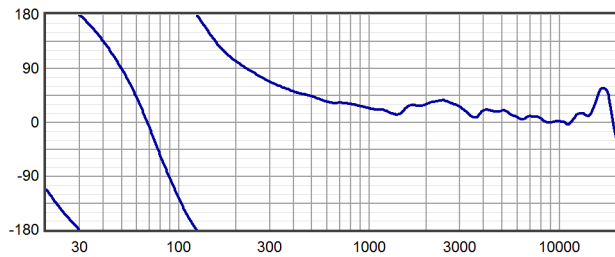

Beamwidth^{7,12}

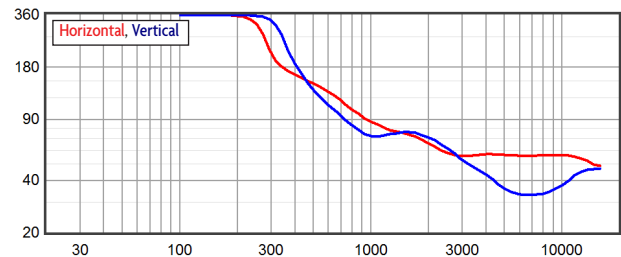

Impedance (ohms)

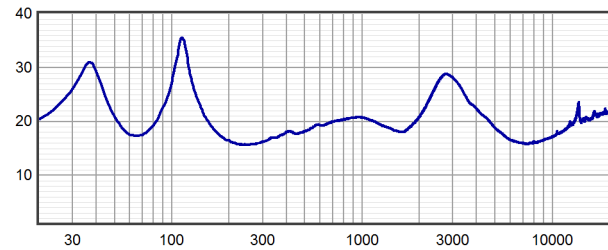

Directivity Index (dB)¹³

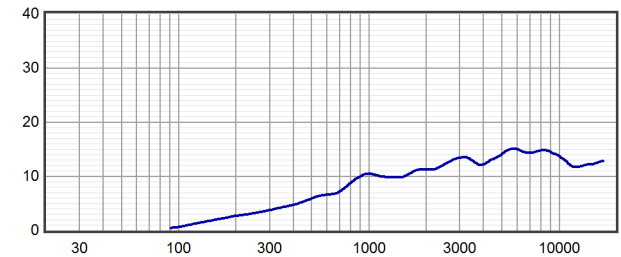



Horizontal Polar Response (30 dB Scale, 6 dB per Major Division)

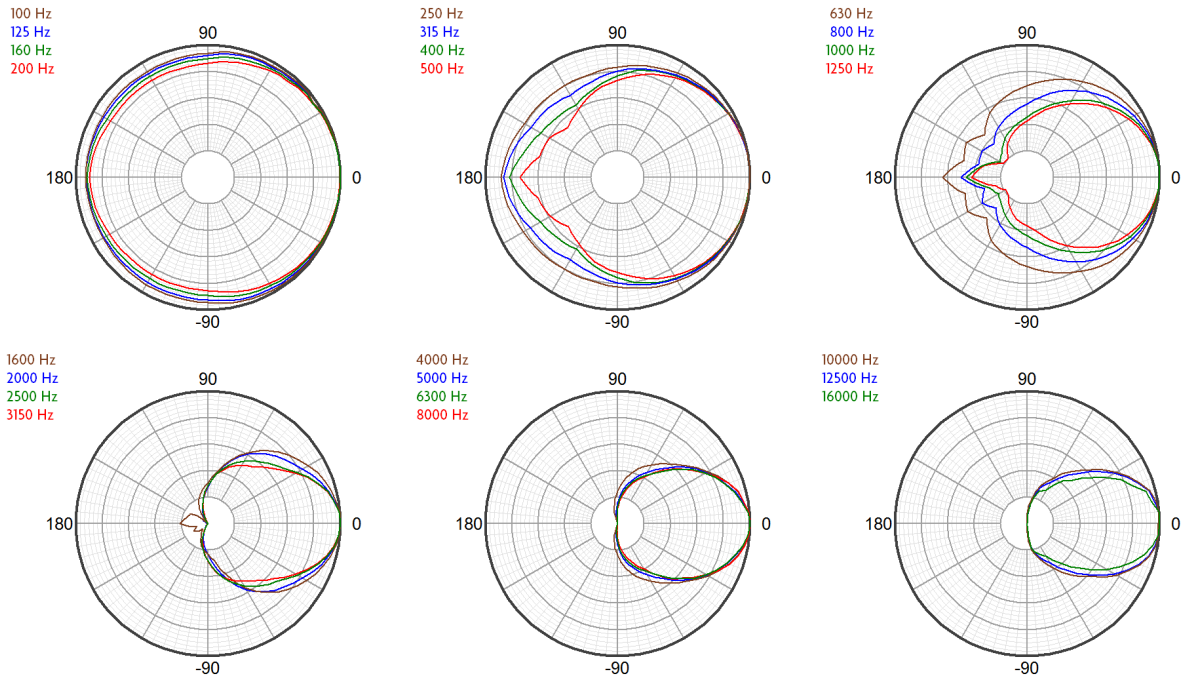

Vertical Polar Response (30 dB Scale, 6 dB per Major Division)

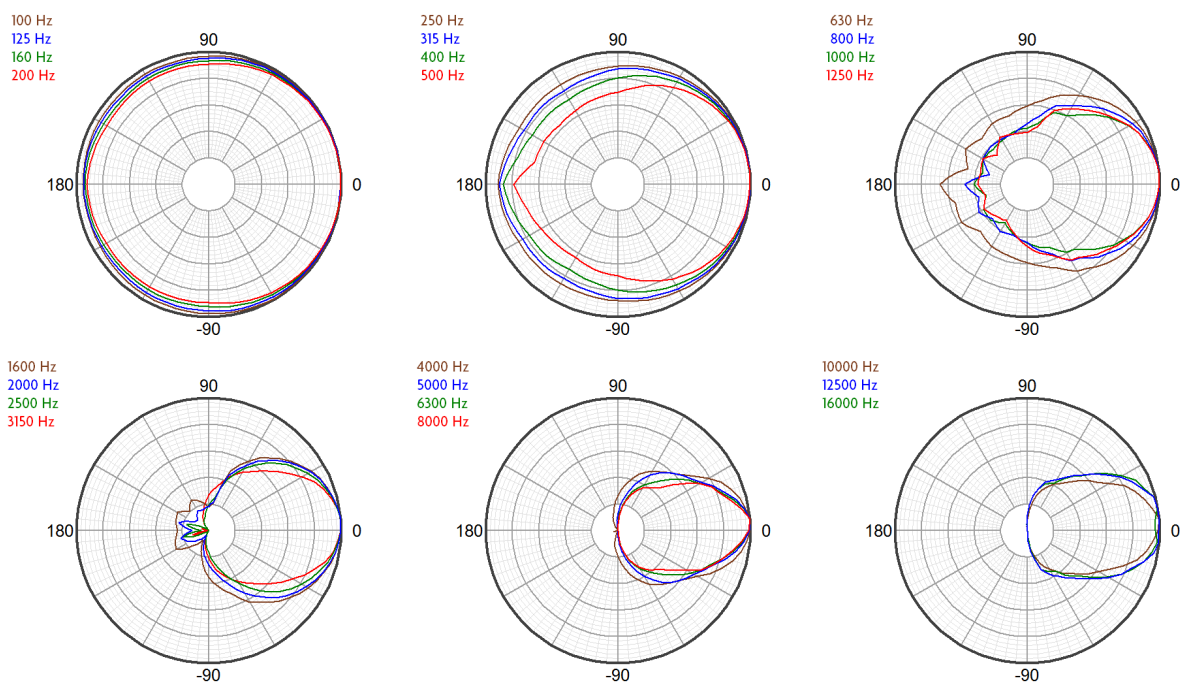



Technologies

The proprietary horns employed in the CX Series represent a modern digital-signal-processing-aware update to the traditional horn-loaded coaxial loudspeaker concept. The well-known benefits of the coaxial approach have been realized without the familiar shortcomings of historical designs. Fulcrum Acoustic's **Temporal Equalization™ (TQ™)** digital signal processing techniques eliminate midrange colorations and high frequency harshness while producing a smooth, seamless coverage pattern through the crossover range. In fact, the coaxial transducers were designed from the ground up to take advantage of the unique capabilities of TQ™.

The coaxial transducer in the CX1265 includes a 3 inch diaphragm compression driver. The large diaphragm area permits the compression driver to operate at frequencies too low for smaller

compression drivers to handle. This allows the high frequency horn to smooth the polar response of the low frequency section in the frequency range where the horn would otherwise cause shadowing. It also allows the compression driver to produce extreme sound pressure levels with an effortless sonic character.

The coaxial woofer's large radiating surface works in conjunction with the HF horn to improve directional control at the bottom of the horn's operating range, increasing directional control beyond what can be accomplished by the horn alone. The coaxial transducer's compact, neodymium magnet not only minimizes weight, but also allows very tight spacing between the compression driver and woofer voice coils. The delay between the driver outputs is thereby minimized, which allows the coaxial device to work well with a passive crossover.

Connection Diagram

2-way, Single-Amp

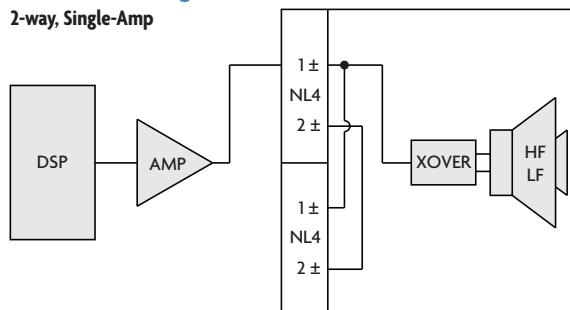

Mechanical Specification Drawings

2D and 3D DWG dimensional drawings are available for download at www.fulcrum-acoustic.com/support.

Notes

- ¹ **Performance Specifications** All acoustic specifications rounded to nearest whole number. External DSP with Fulcrum Acoustic-provided settings is required to achieve the specified performance.
- ² **Operating Range** The frequency range within which the processed response is within 10 dB of the average.
- ³ **Power Handling** Based on the AES power handling of the transducers.
- ⁴ **Nominal Sensitivity** The 1-meter-referenced SPL produced by a 1 watt band limited pink noise signal, with no processing applied.
- ⁵ **Equalized Sensitivity** The 1-meter-referenced SPL produced when an EIA-426-B signal is applied to an equalized loudspeaker system, at a level which produces a total power of 1 watt, in sum, to the loudspeaker subsections.
- ⁶ **Equalized Maximum SPL** The 1-meter-referenced SPL produced when an EIA-426-B signal is applied to an equalized loudspeaker system, at a level which drives at least one subsection to its rated power.
- ⁷ **Resolution** All response graphs are subjected to 1/6 octave cepstral smoothing with a gaussian weighting function.
- ⁸ **Axial Sensitivity** The SPL plotted against frequency for a 1 watt swept sine wave, referenced to 1 m with no signal processing.
- ⁹ **Axial Processed Response** The axial magnitude response with recommended signal processing applied.
- ¹⁰ **Axial Processed Phase Response** The axial phase response with recommended signal processing applied, and latency removed.
- ¹¹ **Horizontal / Vertical Off Axis Responses** The magnitude response at various angles off axis, with recommended signal processing applied.
- ¹² **Beamwidth** The angle between the -6 dB points in a loudspeaker's polar response.
- ¹³ **Directivity Index (Di)** The ratio of the on-axis sound pressure squared to the spherical average of the sound pressure squared at a particular frequency expressed in dB. To convert the directivity index to directivity factor (Q) use the formula $10^{Di/10}$.



product specification

Notes:

1. Net Weight = Approx. 32.0 lb / 14.5 kg
2. Ship Weight = Approx. 40.0 lb / 18.1 kg
3. Symbol = M10x1.5 eye bolt angle point
4. Symbol = M10x1.5 nut plate
5. Symbol = CoG
6. Symbol = CoG
7. Drawing representative of:
CX1226, CX1265, CX1277, CX1295

REVISIONS

REV	DESCRIPTION	APPR / DATE
5	SWAP INPUT & ID LABEL	RAF 10/21/09
6	ADD SHIPPING WEIGHT	RAF 12/7/11
7	DMNIMOUNT TO 'THIRD PARTY' IN NOTE 5	RAF 1/13/12
8	CHANGE DRAWING NAME TO 'CX12 SERIES'	RAF 5/9/12
9	ADD 'CX1226' TO NOTE 7	RAF 4/22/13
10	REMOVE PAN/TILT MOUNT POINTS	RAF 7/28/16
11	UPDATE DIMS, FIX DRAWING ERRORS	RAF 1/18/21

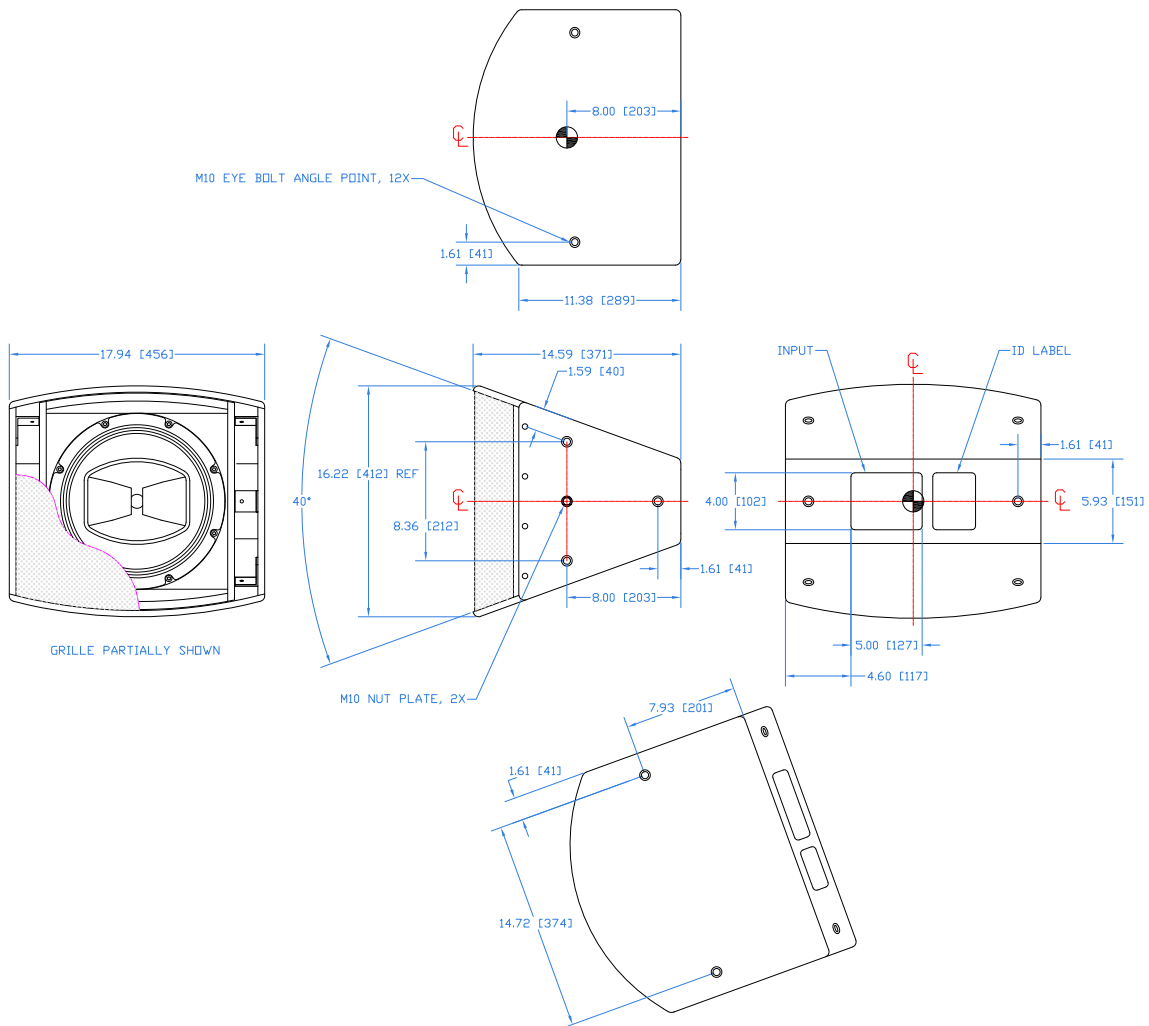

<p>THIRD ANGLE PROJECTION</p>	<p>UNLESS OTHERWISE SPECIFIED: ALL DIMENSIONS ARE IN INCHES</p> <p>TOLERANCE IN INCHES .XX1 .XX±.015 .XXX±.005 FRACTIONS ±1/32 ANGLES ±1/2°</p> <p>(XXX) = REF DIMS NO TOLERANCE IMPLIED</p> <p>TSC = THEORETICAL SHARP CORNER</p> <p>DIMENSIONS ACROSS CENTERLINES TO BE SYMMETRICAL</p>	<p>STATUS RELEASED</p>		<p>FULCRUM ACOUSTIC, LLC 670 LINWOOD AVE., LINWOOD, MA 01525 USA</p>	
		<p>APPROVALS</p> <p>DRAWN: DWG</p> <p>CHECKED: RAF</p> <p>DES ENG:</p> <p>MFG ENG:</p>	<p>DATE</p> <p>2/10/09</p> <p>6/12/09</p>	<p>TITLE: Mechanical Spec, CX12 Series</p>	
<p>THIS DRAWING IS THE PROPERTY OF FULCRUM ACOUSTIC, AND SHALL NOT BE COPIED, REPRODUCED, OR USED AS THE BASIS FOR MANUFACTURE OR SALE OF APPARATUS WITHOUT WRITTEN AUTHORIZATION. DO NOT SCALE DRAWING.</p>		<p>DWG. NO. 820-100-014</p>		<p>REV 11</p>	

Drawing is reduced. Do not scale.



product specification, weather-resistant (WR) version

Notes:

1. Net Weight = Approx. 26.7 lb / 12.1 kg
2. Ship Weight = Approx. 34.0 lb / 15.4 kg
3. Symbol = M10x1.5 eye bolt angle point
4. Symbol = M10x1.5 nut plate
5. Symbol = CoG
6. Enclosure construction:
Fiberglass Reinforced Polyurethane
7. Drawing representative of:
CX1226-WR, CX1265-WR,
CX1277-WR, CX1295-WR

REVISIONS

REV	DESCRIPTION	APPR / DATE
1	NEW ISSUE, WR VERSION OF 820-100-014	3/02/10
2	GENERAL DRAWING UPDATES	11/19/15
3	REMOVE PAN/TILT MOUNT POINTS	7/28/16
4	DRAWING UPDATES - FRP	DEW 4/3/18
5	MOVE INPUT, CHANGE COVER PLATE	RAF 1/15/21

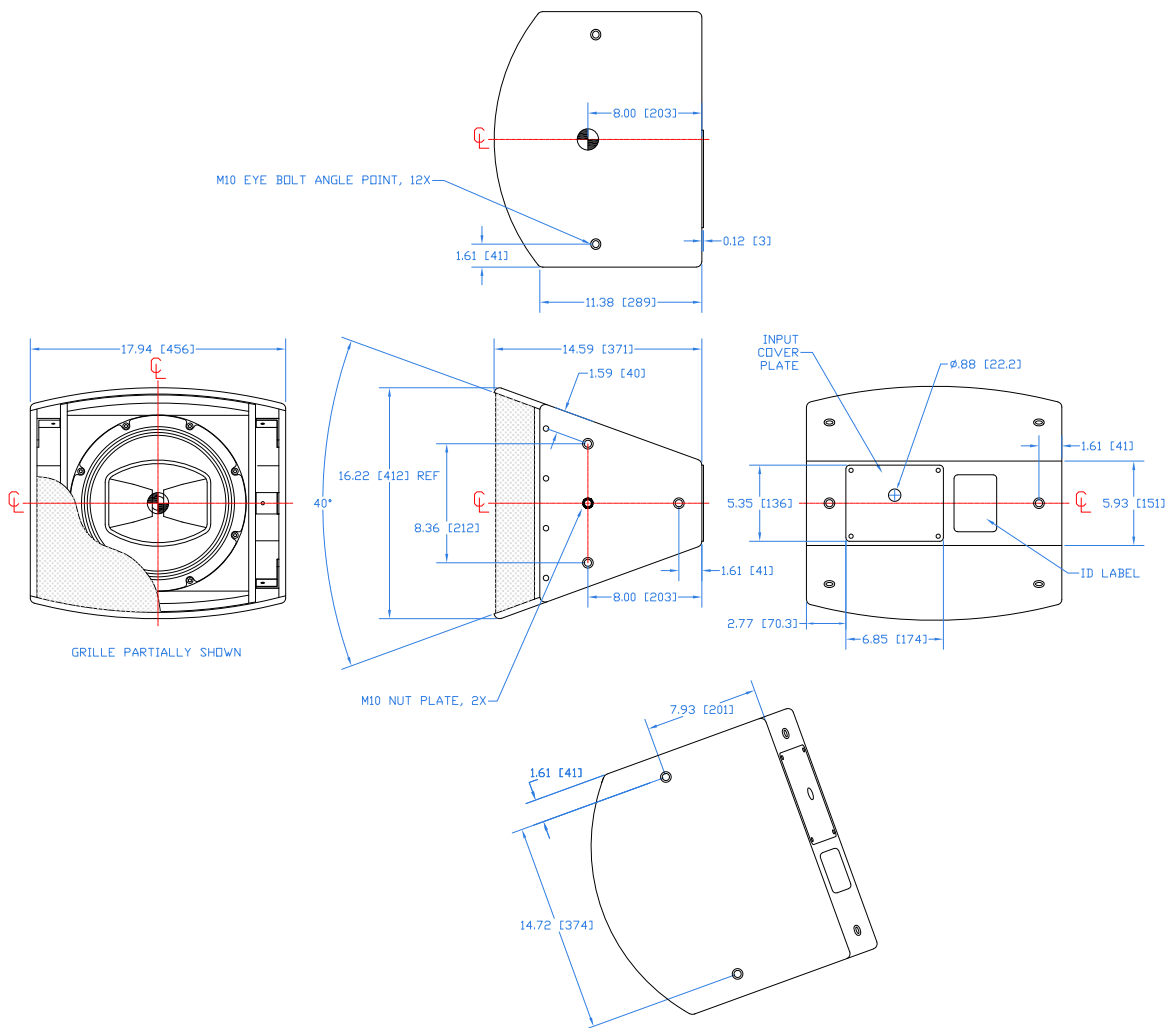

<p>THIRD ANGLE PROJECTION</p>	<p>UNLESS OTHERWISE SPECIFIED: ALL DIMENSIONS ARE IN INCHES</p> <p>TOLERANCE IN INCHES .XX±.015 .XXX±.005 FRACTIONS ±1/32 ANGLES ±1/2°</p> <p>(X.XX) = REF DIMS NO TOLERANCE IMPLIED</p> <p>TSC = THEORETICAL SHARP CORNER</p> <p>DIMENSIONS ACROSS CENTERLINES TO BE SYMMETRICAL</p>	<p>STATUS RELEASED</p>		<p>FULCRUM ACOUSTIC, LLC 670 LINWOOD AVE., LINWOOD, MA 01525 USA</p>
		<p>APPROVALS</p> <p>DATE</p>	<p>DATE</p>	
<p>THIS DRAWING IS THE PROPERTY OF FULCRUM ACOUSTIC, AND SHALL NOT BE COPIED, REPRODUCED, OR USED AS THE BASIS FOR MANUFACTURE OR SALE OF APPARATUS WITHOUT WRITTEN AUTHORIZATION. DO NOT SCALE DRAWING.</p>	<p>DRAWN: DWG</p> <p>CHECKED:</p> <p>DES ENG:</p> <p>MFG ENG:</p>	<p>3/02/10</p>	<p>A</p>	<p>SHEET 1 OF 1</p> <p>SCALE: 1:12</p>
		<p>DWG. NO. 820-100-031</p>	<p>REV 5</p>	

Drawing is reduced. Do not scale.

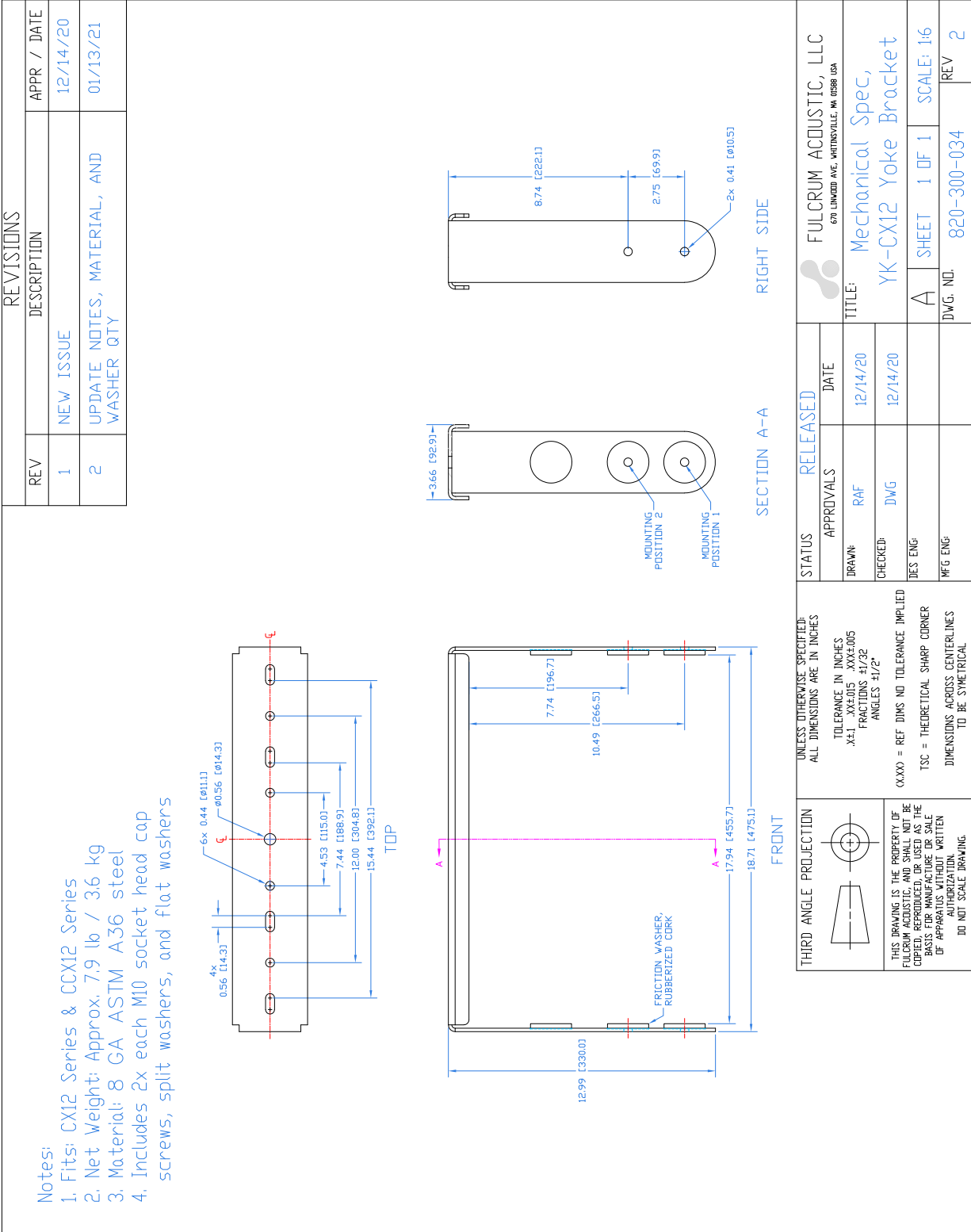

Drawing is reduced. Do not scale.



REVISIONS	
REV	DESCRIPTION
1	NEW ISSUE
2	UPDATE DIMS
APPR / DATE	APPR / DATE
	RAF 12/14/20
	RAF 01/13/21

Notes:
 The YK-CX12 yoke bracket is designed to mount CX12 & CCX12 Series loudspeakers in a horizontal orientation. It is fitted with two mounting holes which allow the installer to vary the distance between the loudspeaker enclosure and the mounting surface.
 Note that the range of motion is restricted when the enclosure is mounted closer to the yoke. The maximum range of motion is achieved when the enclosure is mounted to the holes nearest the end of the bracket arms.

19.60 [497.9]

MOUNTING POSITION 1

16.85 [428.1]

MOUNTING POSITION 2

18.08 [459.3]

18.77 [476.8]

52°

THIRD ANGLE PROJECTION	
	THIS DRAWING IS THE PROPERTY OF FULCRUM ACOUSTIC, AND SHALL NOT BE COPIED, REPRODUCED, OR USED AS THE BASIS FOR MANUFACTURE OR REPAIR OF APPARATUS WITHOUT WRITTEN AUTHORIZATION. DO NOT SCALE DRAWING.

UNLESS OTHERWISE SPECIFIED: ALL DIMENSIONS ARE IN INCHES	
TOLERANCE IN INCHES	.X41 .XXE.005 .XXXE.005
FRACTIONS 1/16 1/8 1/4 3/8 1/2	ANGLES 1/2°
(X.XX) = REF DIMS NO TOLERANCE IMPLIED	TSC = THEORETICAL SHARP CORNER
DIMENSIONS ACROSS CENTERLINES	TO BE SYMMETRICAL

STATUS	RELEASED	DATE	FULCRUM ACOUSTIC, LLC 670 LINWOOD AVE. WHITINSVILLE, WA 0288 USA
APPROVALS	RAF	12/14/20	TITLE: Mechanical Spec, YK-CX12 + CX12xx Assembly
DRAWN	DVG	12/14/20	
CHECKED			A SHEET 1 OF 1 SCALE: 1:8
DES ENG			DWG. NO. 820-300-035 REV 2
MFG ENG			

Drawing is reduced. Do not scale.